



Mein Name / Datum

Spiegelrätsel 2

Aufgabe:

Spiegle das Objekt an den beiden Spiegelachsen!
Male dann ein Objekt in deinen Lieblingsfarben aus!

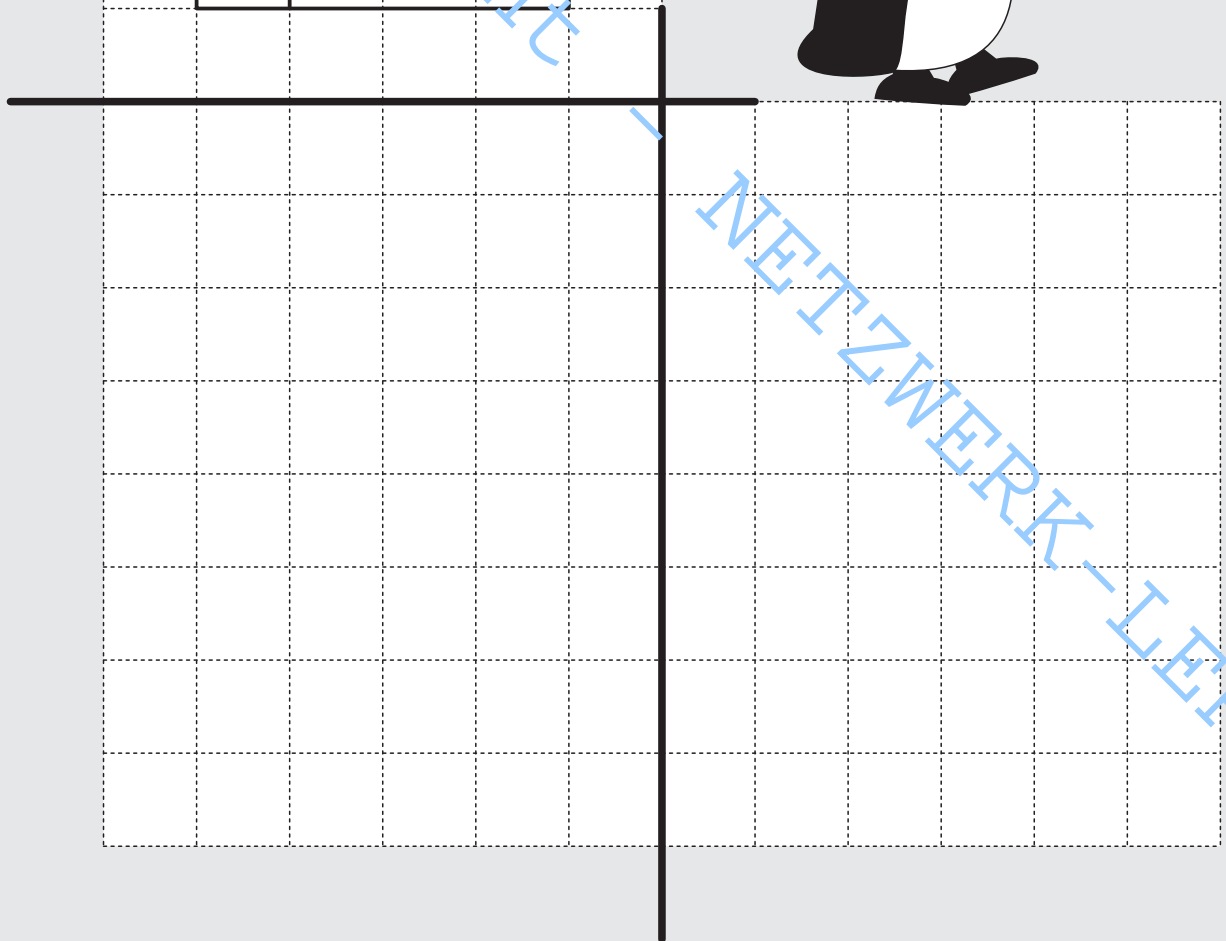
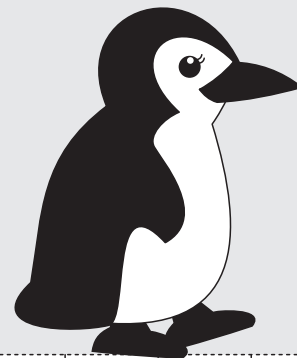
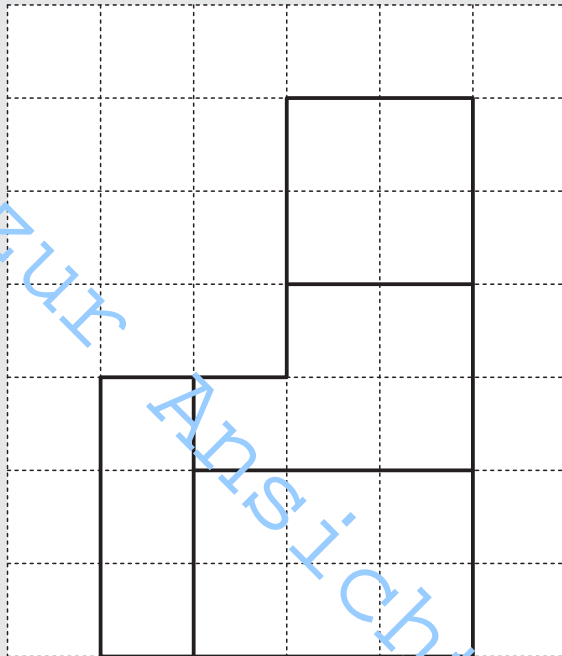

4



Mein Name / Datum

Spiegelrätsel 3

Aufgabe:

Spiegle das Objekt an den beiden Spiegelachsen!
Male dann ein Objekt in deinen Lieblingsfarben aus!

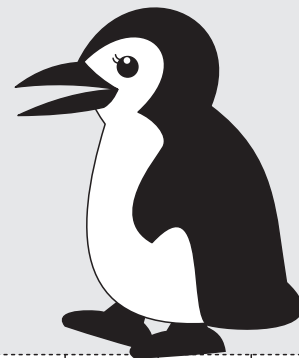
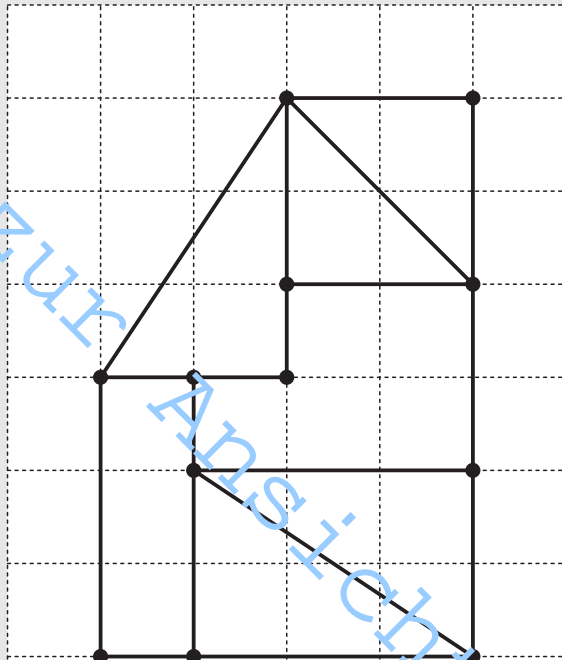

6

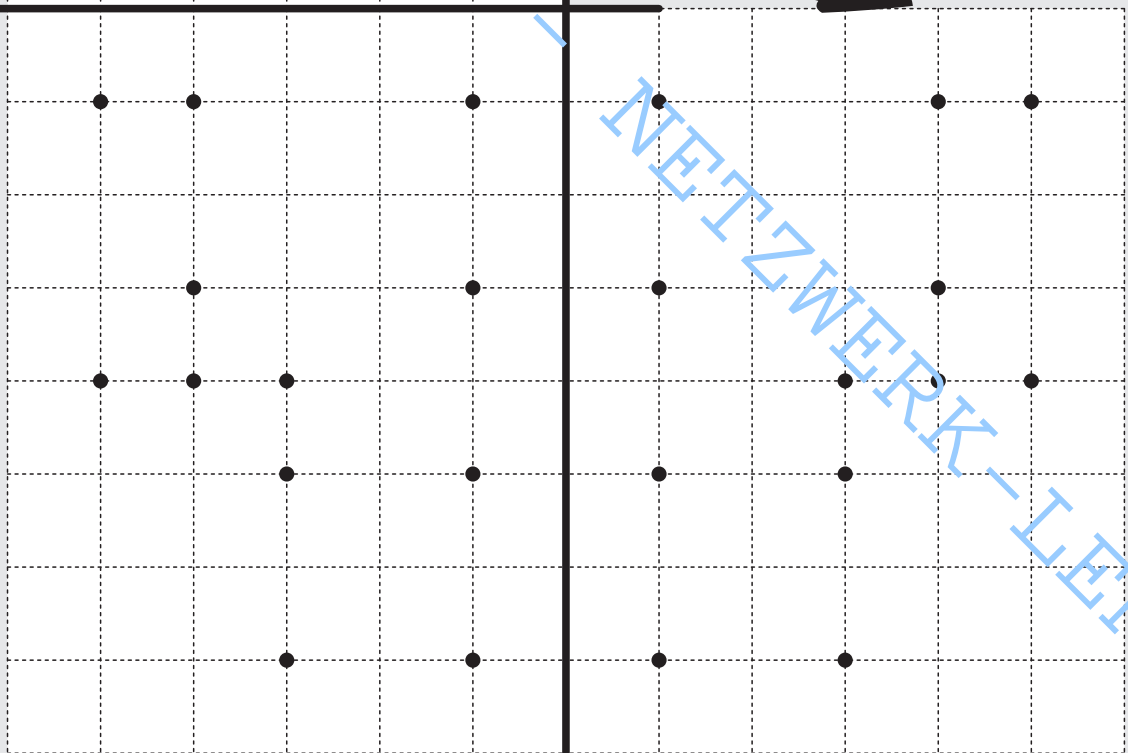



Mein Name / Datum

Spiegelbuchstaben 1

Aufgabe:

Spiegele den Buchstaben an den beiden Spiegelachsen!
Male dann ein Objekt in deinen Lieblingsfarben aus!

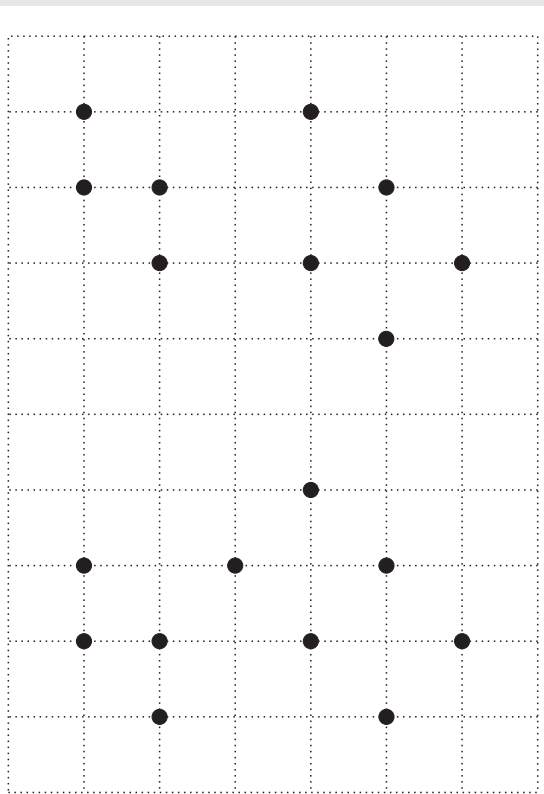
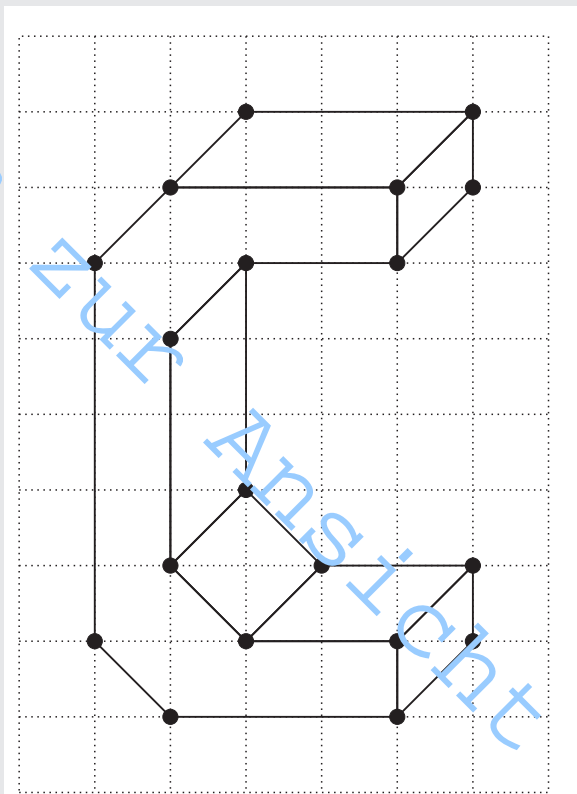
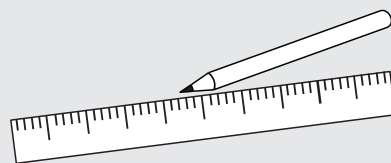

18

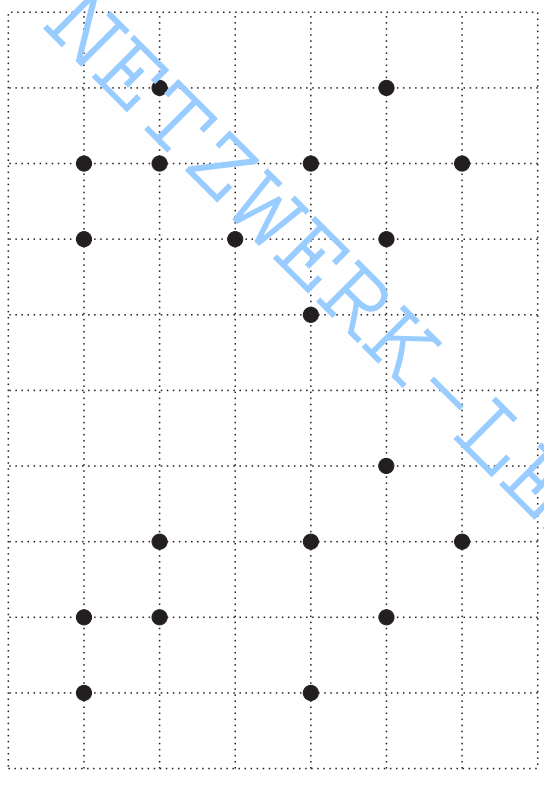
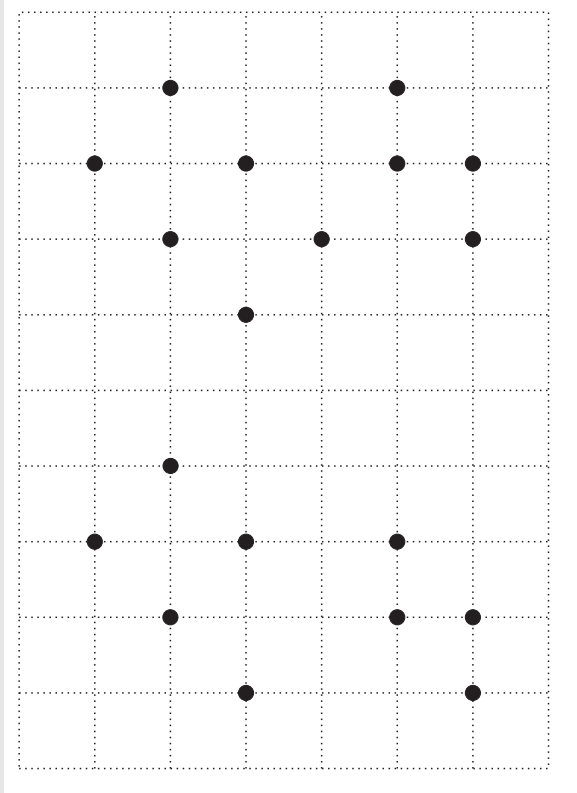



Mein Name / Datum

Spiegelbilder 1 (Lösung)

Aufgabe:

Spiegele das Muster an allen Spiegelachsen!
Male das fertige Bild in deinen Lieblingsfarben aus!

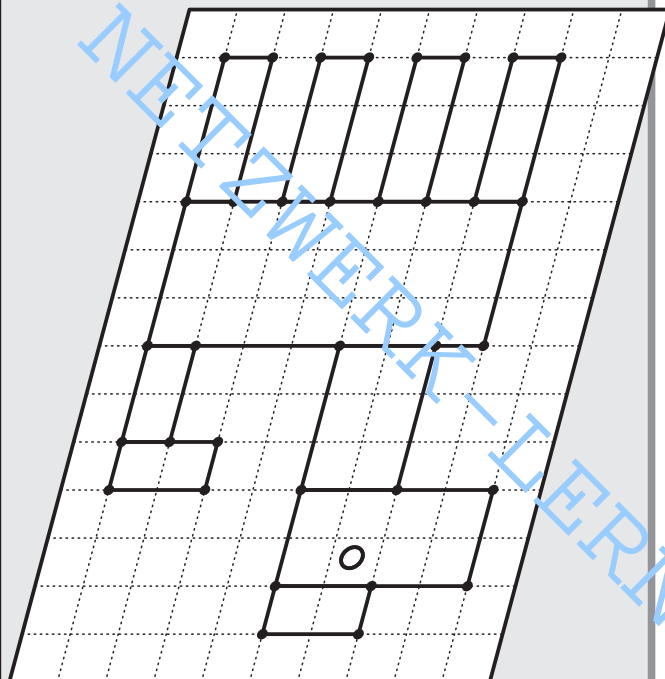
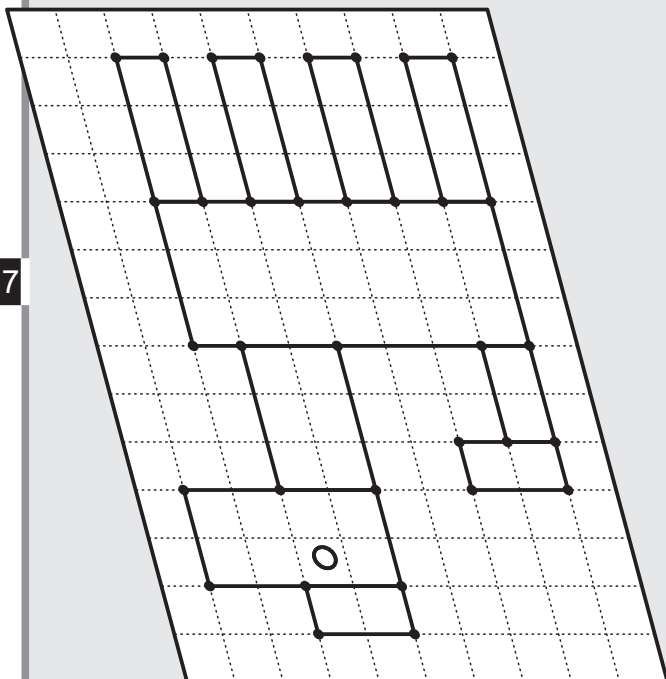
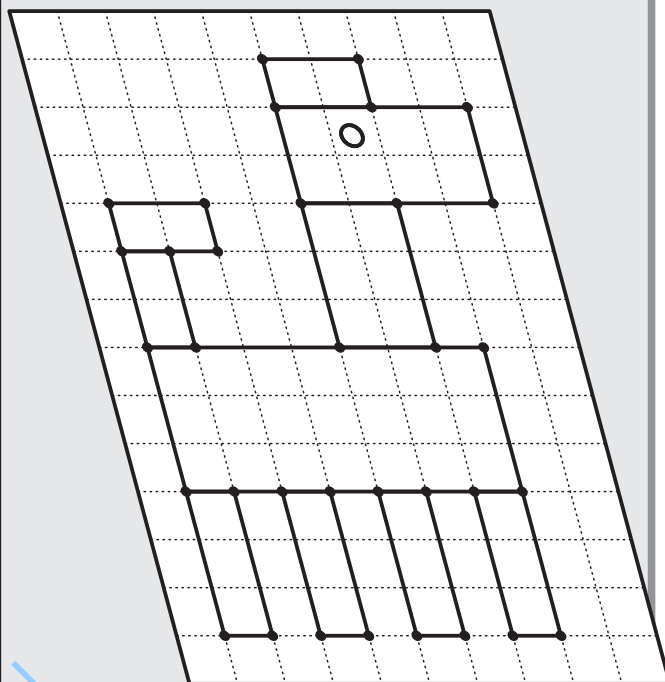
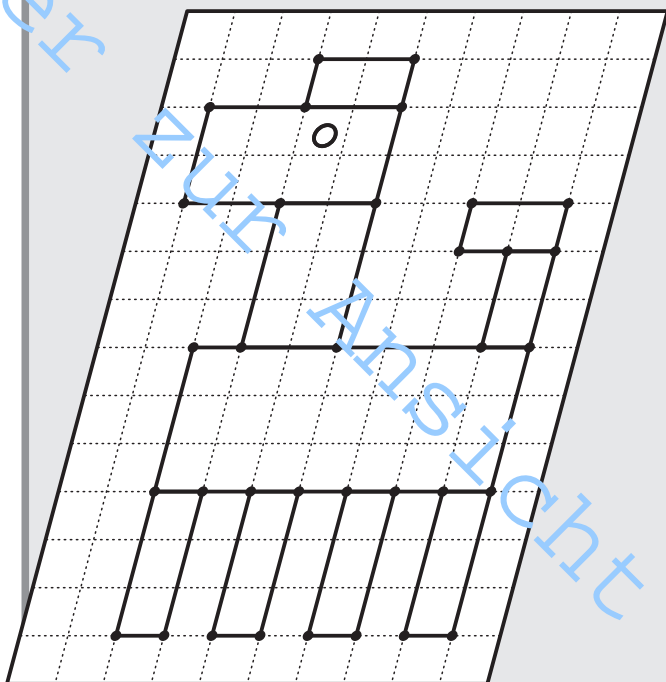
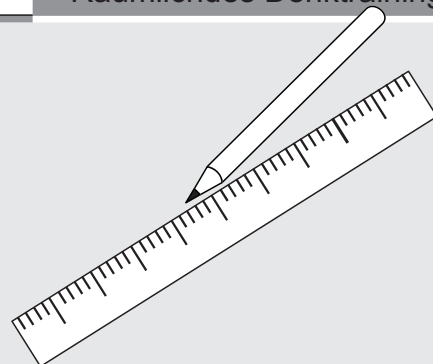

67



Mein Name / Datum

Spiegelspaß 2

Aufgabe:

Spiegle das Muster an der Spiegelachse!
Male das fertige Bild in deinen Lieblingsfarben aus!

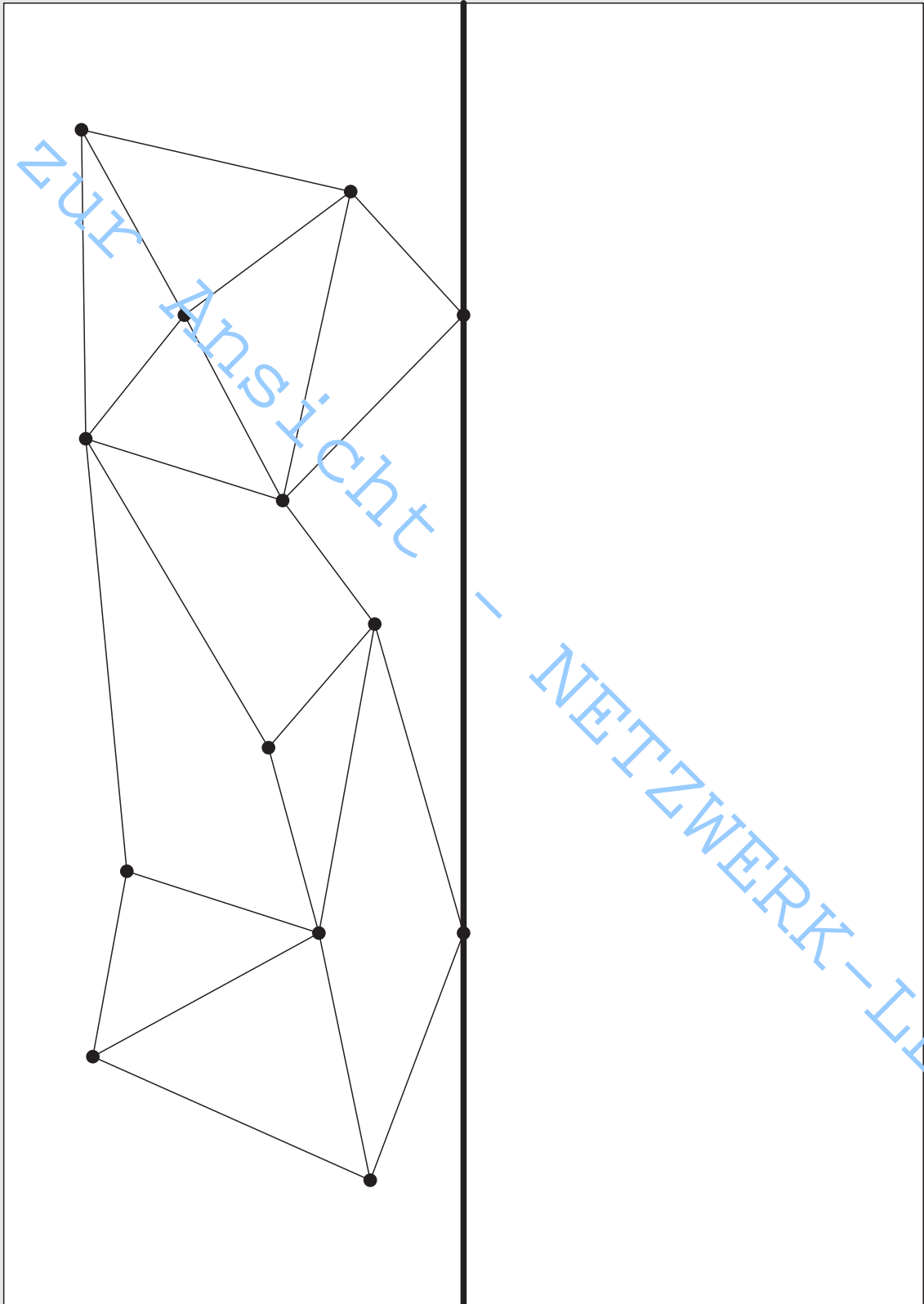
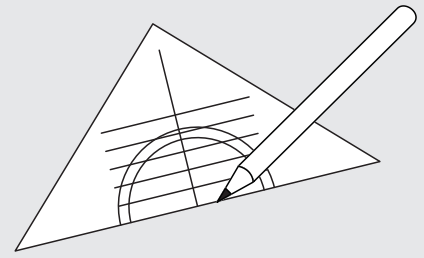

80





Mein Name / Datum

Gitterkreis 4

Aufgabe:

Spiegle das Muster an allen Spiegelachsen!
Male das fertige Bild in deinen Lieblingsfarben aus!

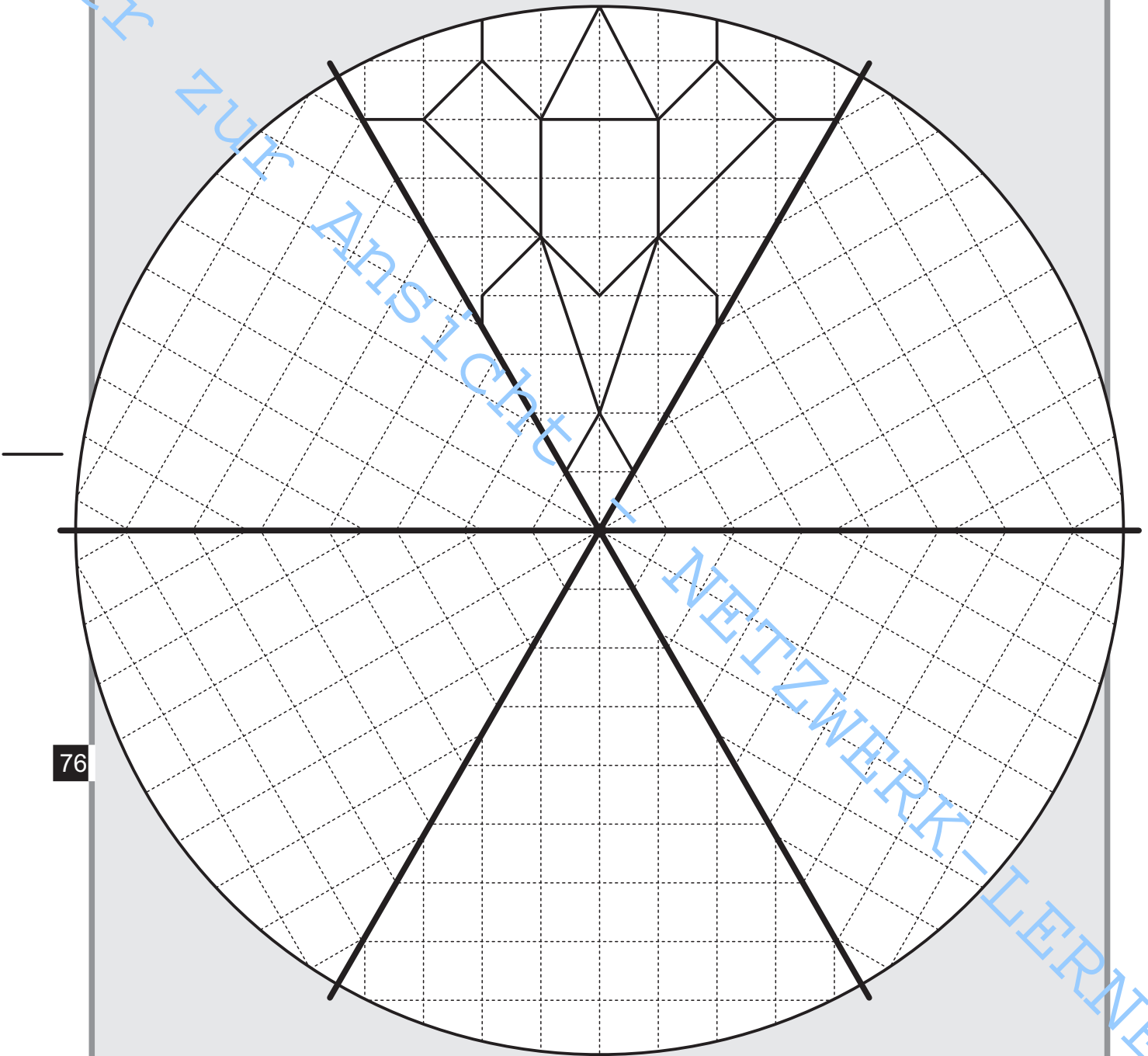
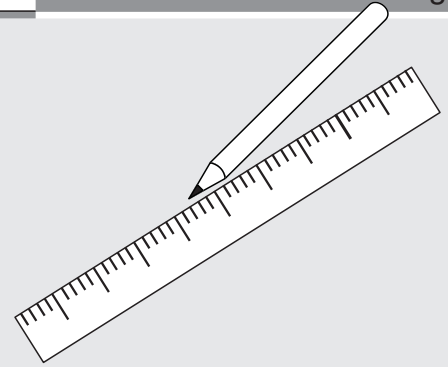

76

