



Name: \_\_\_\_\_









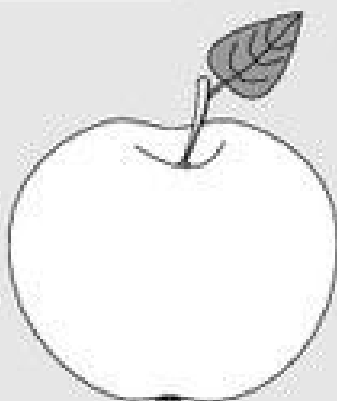

Klasse: \_\_\_\_\_

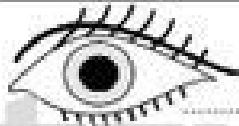
Datum: \_\_\_\_\_

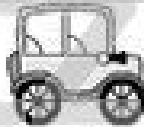
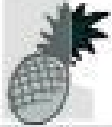
## Verborgene A-Wörter (Lösung)

In dem großen A sind noch weitere 11 Wörter verborgen. Markiere sie und schreibe sie dann in die leeren Felder!



	Affe		Anzug
	Ameise		Auge
	Ampel		Auto
	Ananas		Ast
	Angel		Arm
	Anker		Antenne



netzwerk  
lernen

zur Vollversion



Name:









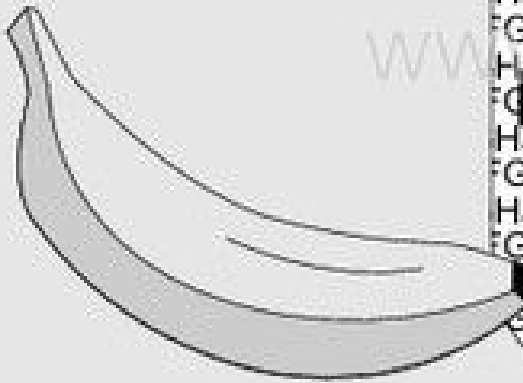



Klasse:

Datum:

# Verborgene B-Wörter

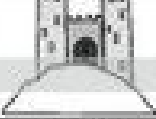
In dem großen B sind noch weitere 11 Wörter verborgen. Markiere sie und schreibe sie dann in die leeren Felder!

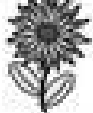

	<b>Ball</b>	
		
		
		
		
		





Name: \_\_\_\_\_







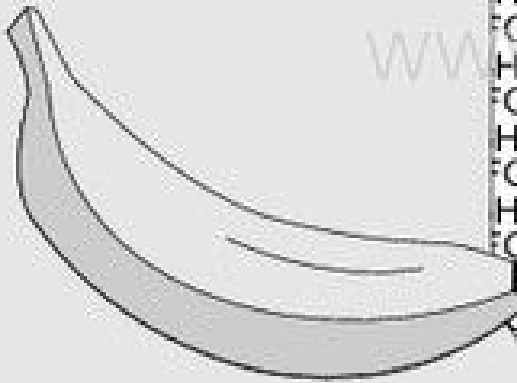

Klasse: \_\_\_\_\_

Datum: \_\_\_\_\_

## Verborgene B-Wörter (L)

In dem großen B sind  
noch weitere 11 Wörter  
verborgen. Markiere sie  
und schreibe sie dann  
in die leeren  
Felder!

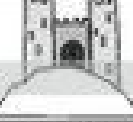

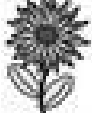
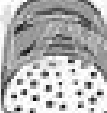
	Ball		Besen
	Brille		Brezel
	Bank		Bein
	Baum		Bett
	Burg		Bluse
	Blume		Brot





Name: \_\_\_\_\_









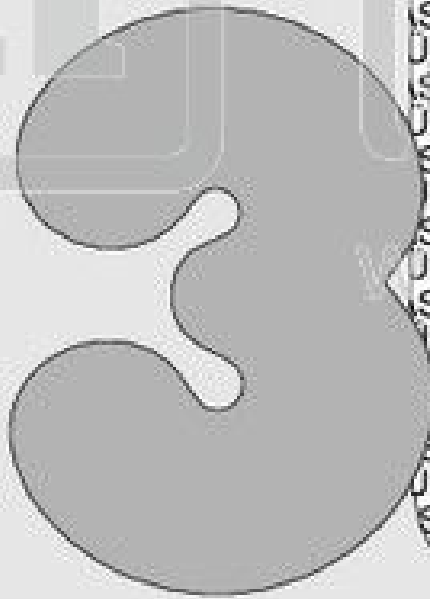



Klasse: \_\_\_\_\_

Datum: \_\_\_\_\_

## Verborgene D-Wörter

In dem großen D sind noch weitere 11 Wörter verborgen. Markiere sie und schreibe sie dann in die leeren Felder!



	<b>Dorn</b>	
	.....	
	.....	
	.....	
	.....	
	.....	





Name: \_\_\_\_\_









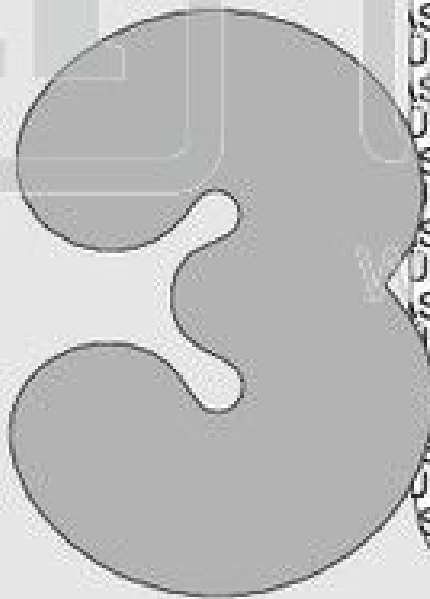

Klasse: \_\_\_\_\_

Datum: \_\_\_\_\_

## Verborgene D-Wörter (L)

In dem großen D sind noch weitere 11 Wörter verborgen. Markiere sie und schreibe sie dann in die leeren Felder!



	Dorn		Dieb
	Dackel		Deckel
	Daumen		Dachs
	Drachen		Dorf
	Dreirad		Dach
	Diamant		Delfin





Name:









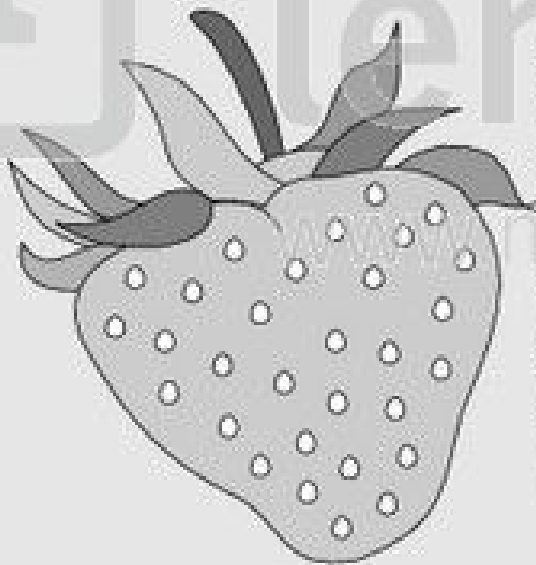

Klasse:

Datum:

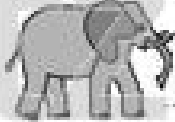
# Verborgene E-Wörter

In dem großen E sind noch weitere 11 Wörter verborgen. Markiere sie und schreibe sie dann in die leeren Felder!



	<b>Essig</b>	
		
		
		
		
		



Name: \_\_\_\_\_









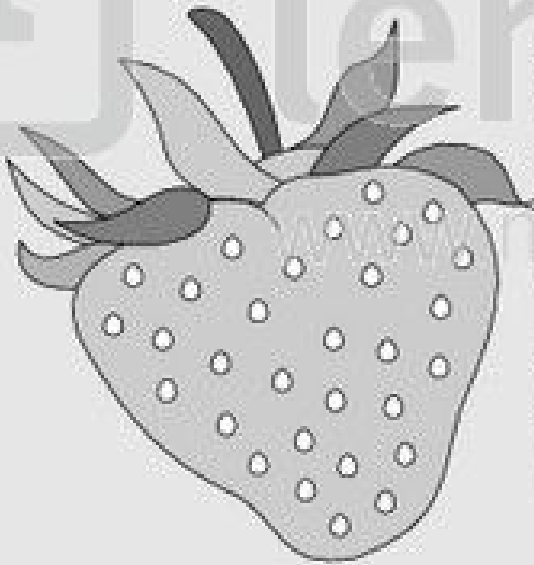

Klasse: \_\_\_\_\_

Datum: \_\_\_\_\_

## Verborgene E-Wörter (L)

In dem großen E sind noch weitere 11 Wörter verborgen. Markiere sie und schreibe sie dann in die leeren Felder!



	Essig		Elch
	Erbsen		Etui
	Eskimo		Elefant
	Etikett		Engel
	Erde		Elster
	Esel		Ente



Name: \_\_\_\_\_

Klasse: \_\_\_\_\_

Datum: \_\_\_\_\_

# Verborgene F-Wörter

In dem großen F sind noch weitere 11 Wörter verborgen. Markiere sie und schreibe sie dann in die leeren Felder!

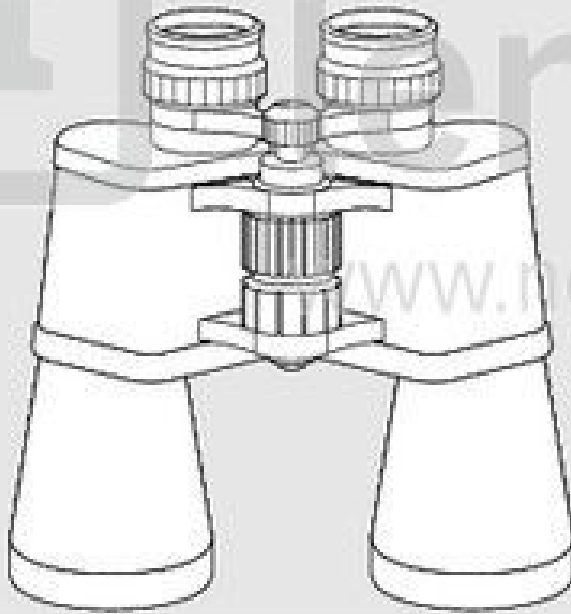

Frau

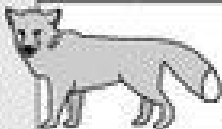
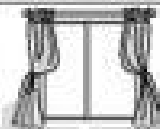

netzwerk lernen

zur Vollversion





Name: \_\_\_\_\_

Klasse: \_\_\_\_\_

Datum: \_\_\_\_\_

## Verborgene F-Wörter (Lösung)

In dem großen F sind noch weitere 11 Wörter verborgen. Markiere sie und schreibe sie dann in die leeren Felder!

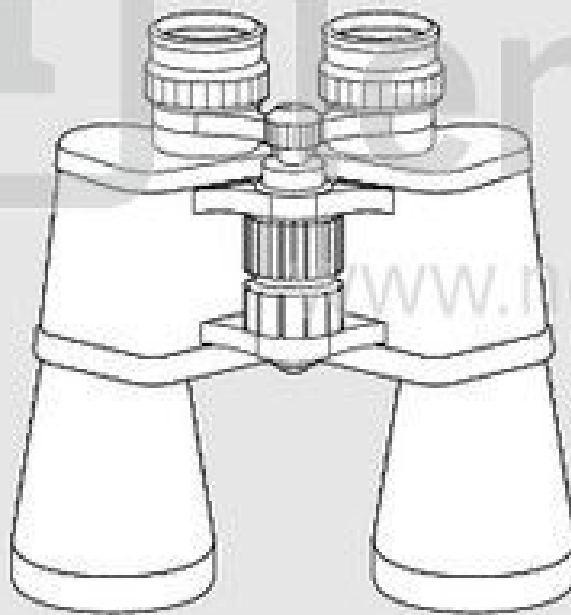

	Frau		Flasche
	Fisch		Fenster
	Feder		Faden
	Frosch		Fahrrad
	Feuer		Fahne
	Fuchs		Fliege





Name:

Klasse:

Datum:

# Verborgene G-Wörter

In dem großen G sind noch weitere 11 Wörter verborgen. Markiere sie und schreibe sie dann in die leeren Felder!

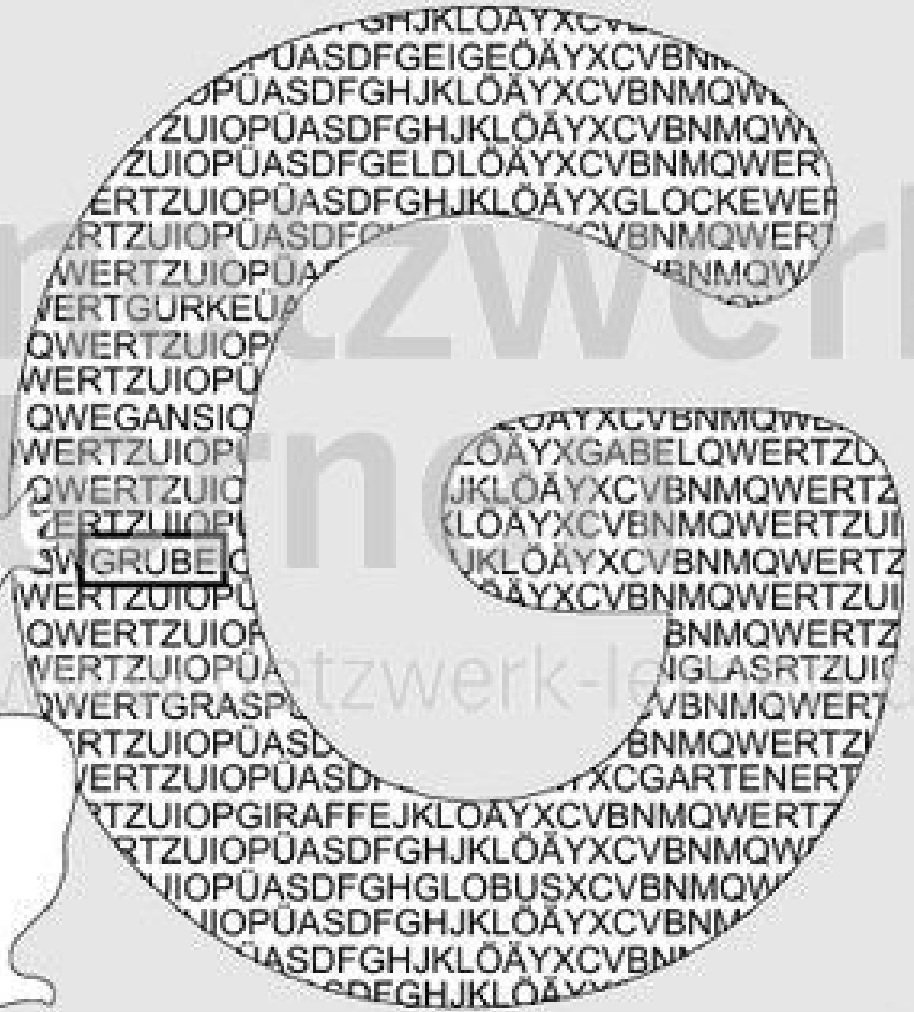

Grube



netzwerk lernen

zur Vollversion