

# Inhaltsverzeichnis

---

Einleitung .....	4
Auswertungsbogen .....	5

## Das Bronze-Training

---



Schreiben .....	6
Schneiden und Kleben .....	14
Reißen und Kleben .....	18
Falten .....	20
Die Bronze-Generalprobe .....	22
Die Bronze-Prüfung .....	24

## Das Silber-Training

---



Schreiben .....	26
Schneiden und Kleben .....	34
Reißen und Kleben .....	38
Falten .....	40
Die Silber-Generalprobe .....	42
Die Silber-Prüfung .....	44

## Das Gold-Training

---



Schreiben .....	46
Schneiden und Kleben .....	54
Reißen und Kleben .....	58
Falten .....	60
Die Gold-Generalprobe .....	62
Die Gold-Prüfung .....	64



## Anhang

---

Feinmotorik-Übungskartei .....	66
--------------------------------	----



Name	Stift- und Sitzhaltung, Anspitzen, Radieren	Größenrelation der Buchstaben/Ziffern zueinander	Schreibrichtung/ formgerechte Buchstaben und Ziffern	Schreiben in Lineatur/ Kästchen	Trainingsblätter																Generalprobe Prüfung									
					1	2	3	4	5	6	7	8	9	10	11	12	13	14	15	16	<input type="checkbox"/> Bronze	<input type="checkbox"/> Silber	<input type="checkbox"/> Gold							

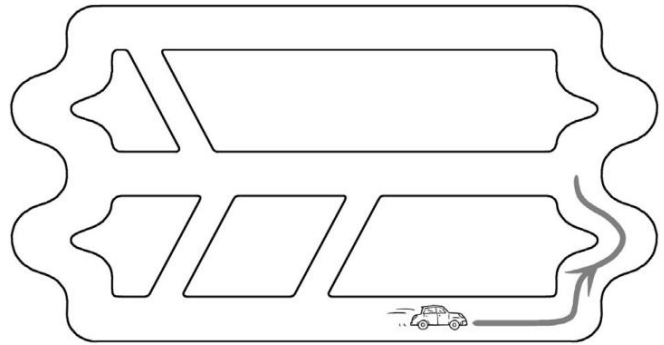
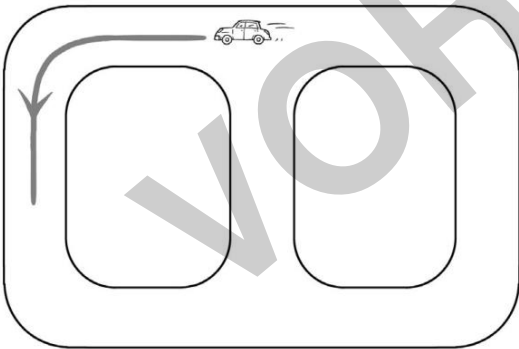
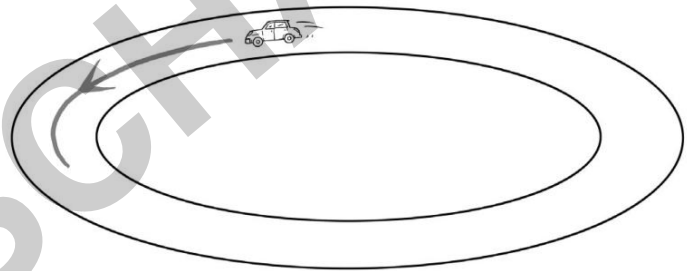
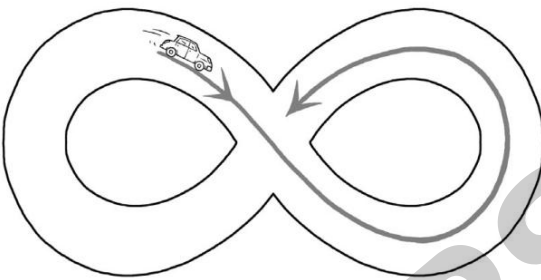

	<p><b>1</b> </p> <p>Spure mit deinem Zeigefinger die hellgrauen Linien nach. Probiere es auch auf dem Tisch, in der Luft und auf dem Rücken eines Mitschülers.</p>	<p><b>2</b> </p> <p>Zeichne auf die Rückseite die hellgrauen Linienformen mit verschiedenen Buntstiften.</p>	<p><b>3</b> </p> <p>Spure auf dieser Blattseite die hellgrauen Linien mit einem Stift nach. Male das Bild zuletzt mit Buntstiften an.</p>	
--	---	---	---	--





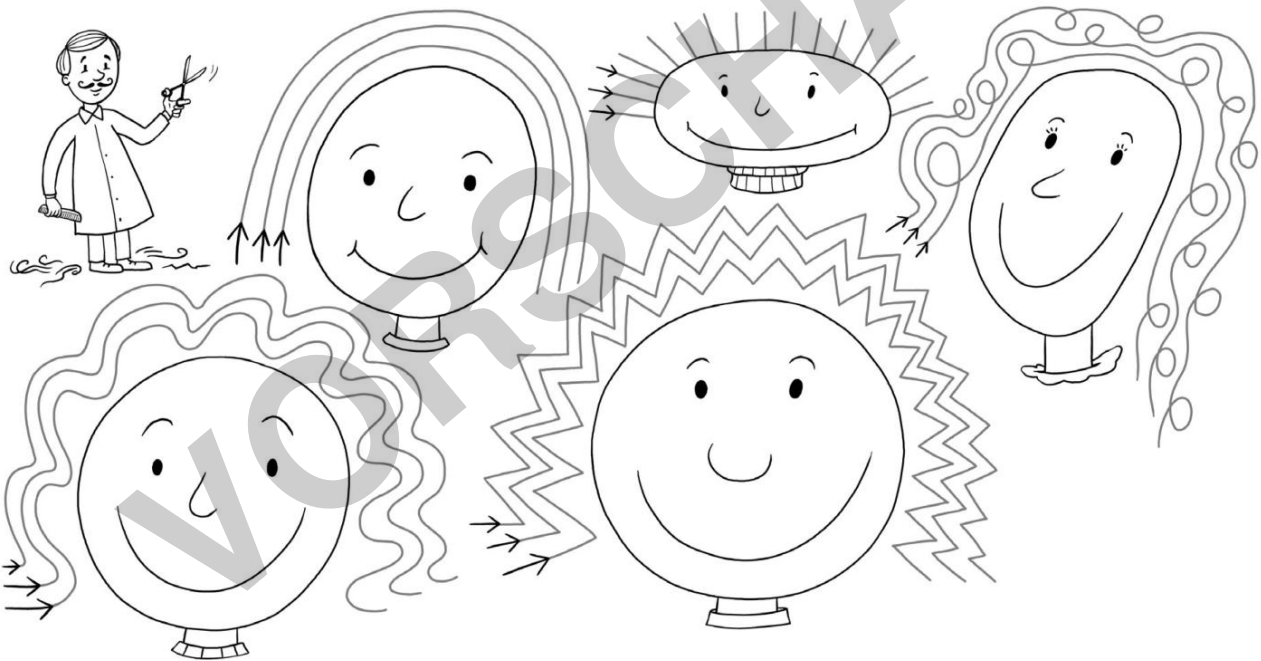

	<p><b>1</b> </p> <p>Spure mit deinem Zeigefinger die hellgrauen Linien nach. Probiere es auch auf dem Tisch, in der Luft und auf dem Rücken eines Mitschülers.</p>	<p><b>2</b> </p> <p>Zeichne auf die Rückseite die hellgrauen Linienformen mit verschiedenen Buntstiften.</p>	<p><b>3</b> </p> <p>Spure auf dieser Blattseite die hellgrauen Linien mit einem Stift nach. Male das Bild zuletzt mit Buntstiften an.</p>	
--	---	---	---	--







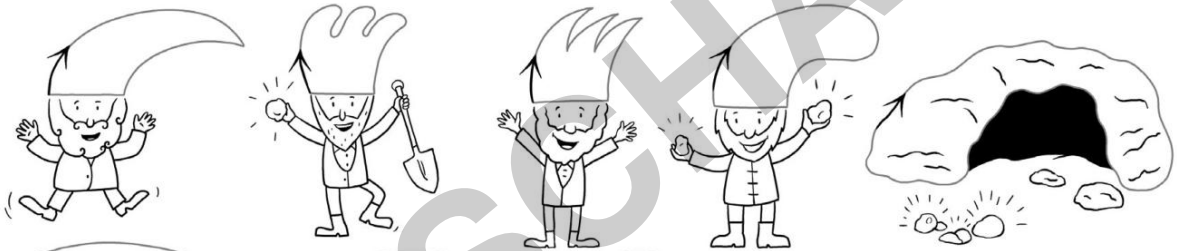

	<p><b>1</b> </p> <p>Spure mit deinem Zeigefinger die hellgrauen Linien nach. Probiere es auch auf dem Tisch, in der Luft und auf dem Rücken eines Mitschülers.</p>	<p><b>2</b> </p> <p>Zeichne auf die Rückseite die hellgrauen Linienformen mit verschiedenen Buntstiften.</p>	<p><b>3</b> </p> <p>Spure auf dieser Blattseite die hellgrauen Linien mit einem Stift nach. Male das Bild zuletzt mit Buntstiften an.</p>	
--	---	---	---	--

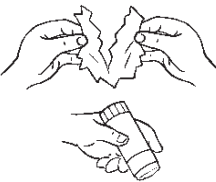
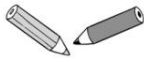



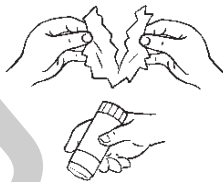

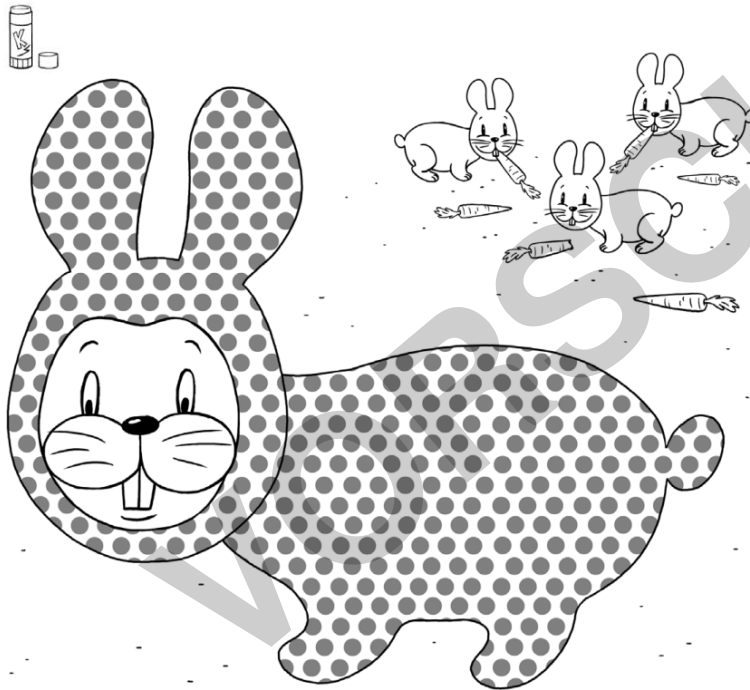
	<p><b>1</b></p>  <p>Male die rechte Fläche mit der Farbe an:</p> 	<p><b>2</b></p>  <p>Schneide die angemalte Fläche aus. Reiß sie in viele kleine Schnipsel.</p>	<p><b>3</b></p>  <p>Klebe die Schnipsel auf die linke Figur. Achte darauf, dass du nicht über den Rand klebst.</p>	
---	---	---	--	---





- 1  Schneide aus.
- 2 Falte entlang der gestrichelten Linie.
- 3  Male an.
- 4 Male, was oder wer hinter dem Fenster steht.

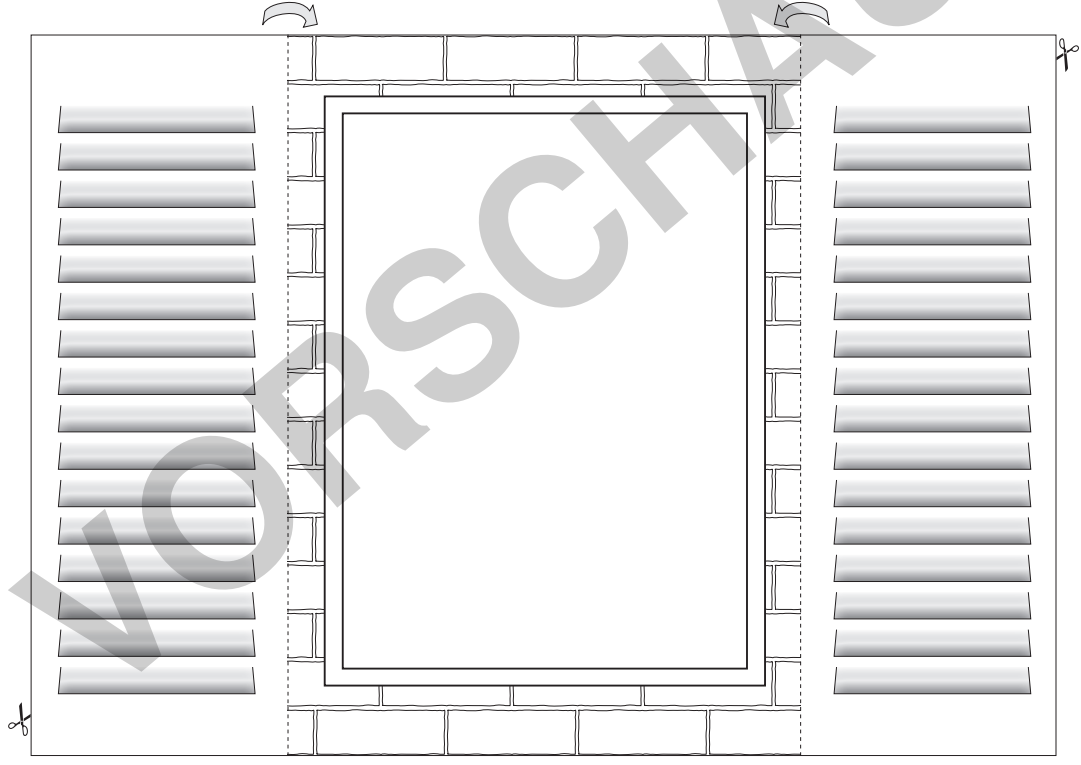
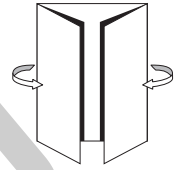

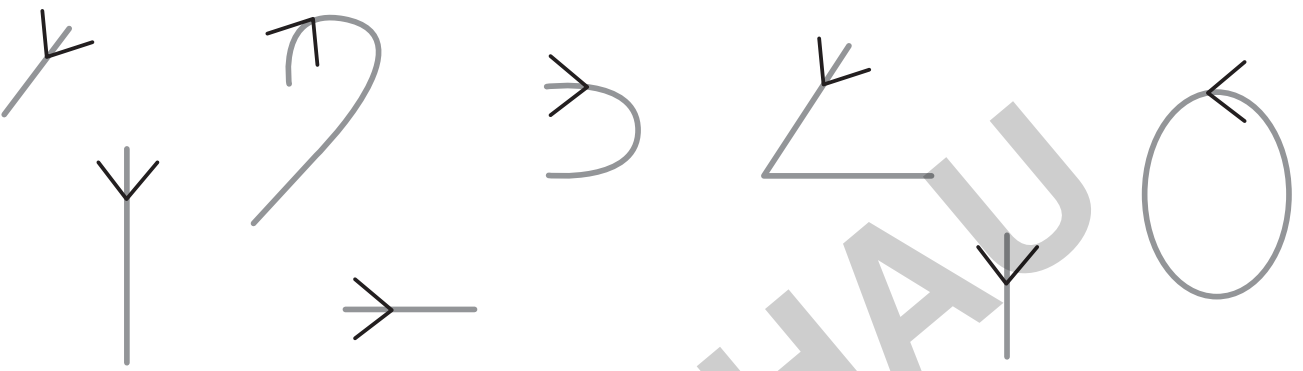

1	1	2	1	3	3	4	0



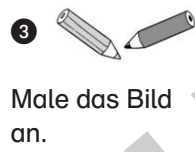
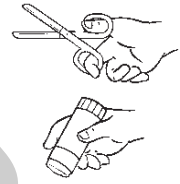

3 Male das Bild an.

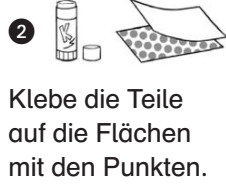

2 Klebe die Teile auf die Flächen mit den Punkten.

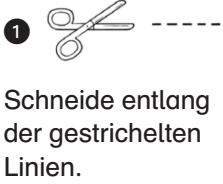

1 Schneide entlang der gestrichelten Linien.

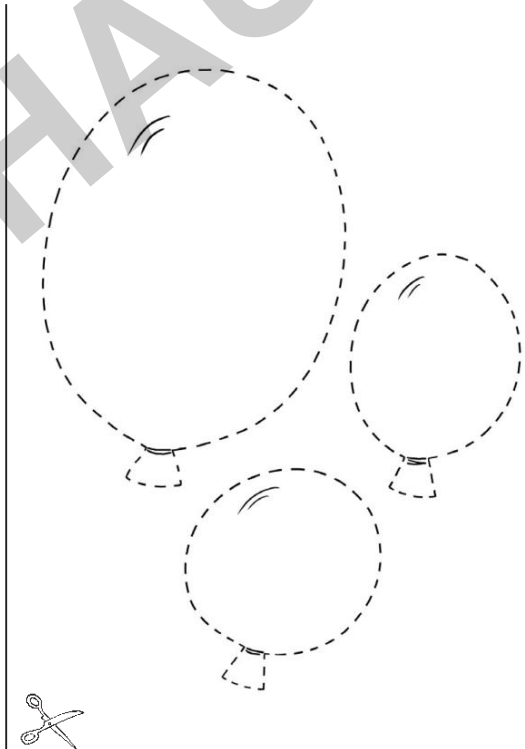
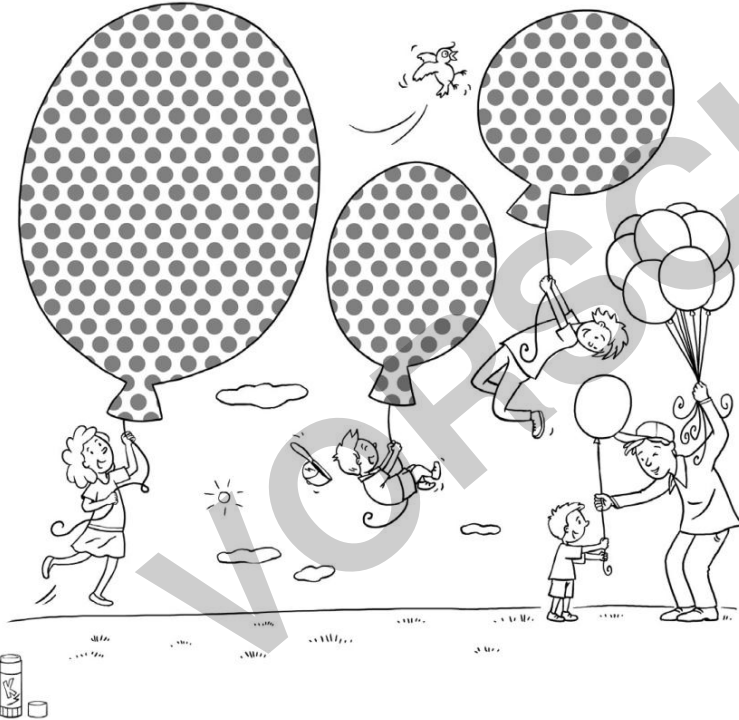
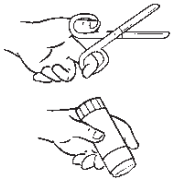

# Silber-Training 16: Der Drachen



1  Schneide aus.

2 Falte nach der Anleitung.

3  Male an.

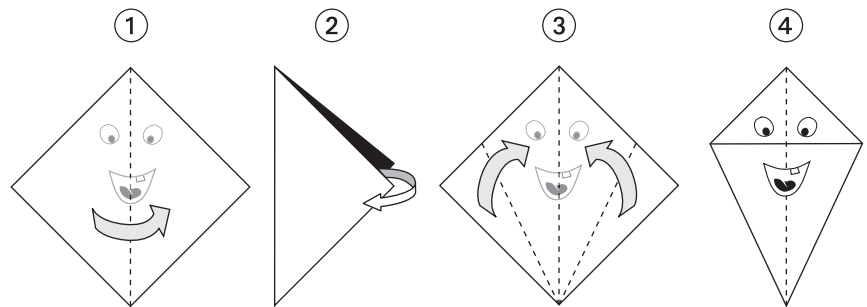

Das Gesicht liegt auf der Rückseite.

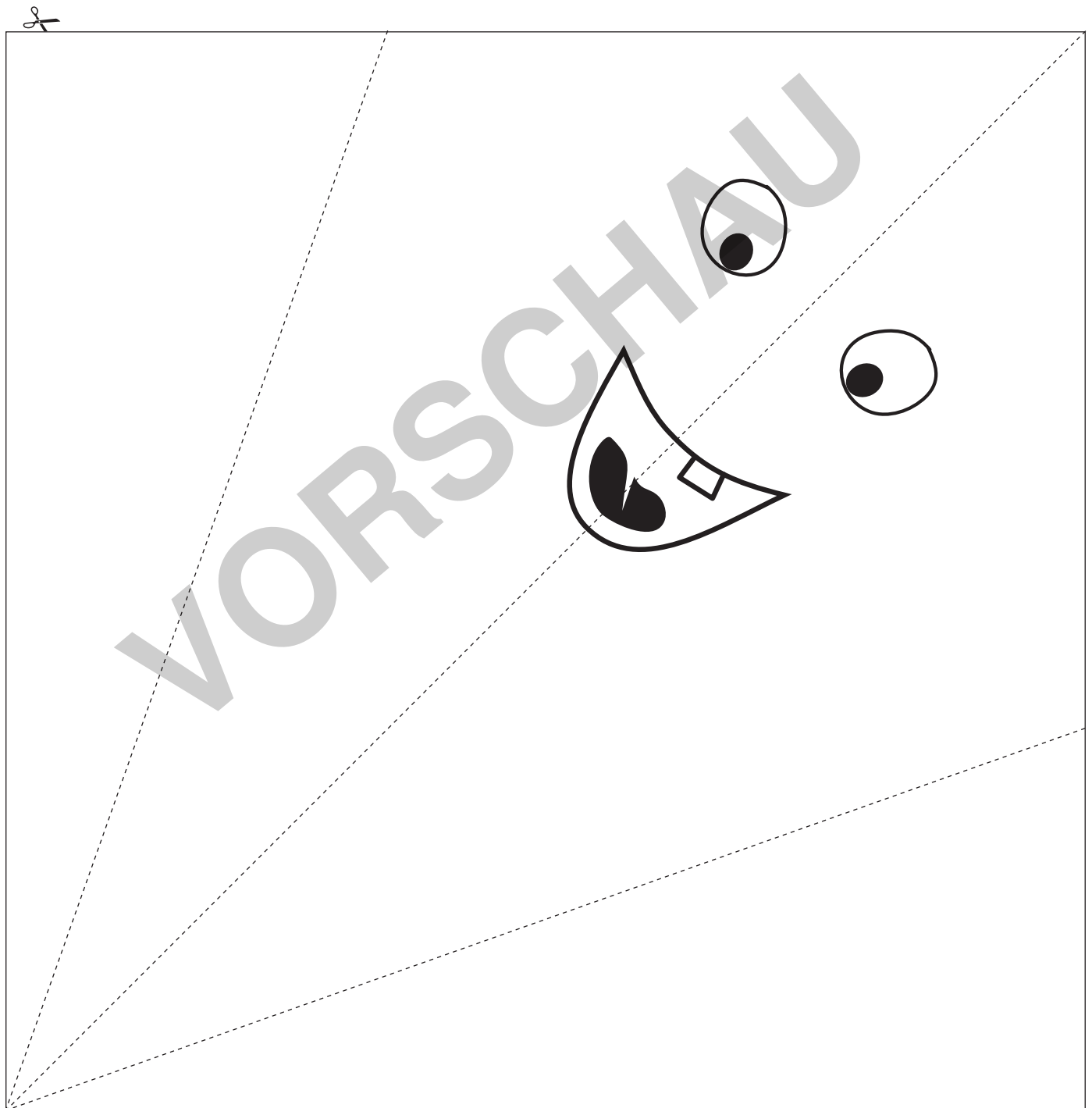

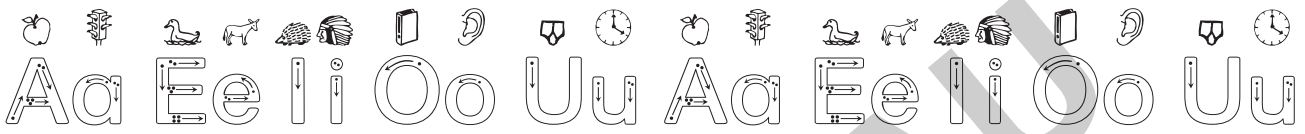

Nn
 Ww
 Bb
 Dd
 Nn
 Ww
 Bb
 Dd

Nn Nn Nn Nn  
 Ww Ww Ww Ww  
 Bb Bb Bb Bb  
 Dd Dd Dd Dd



