



Einen **Bienezüchter** nennt man **Imker**.

Er hält **Honigbienen** in einem **Bienenstock**.

Der **Bienenstock** ist aus Holz **gebaut**.

In den Holz**kästen** **stecken** Wachs**platten**.

Dort **bauen** die **Bienen** ihre **Waben**.

In den **Waben** **lagern** sie ihren **Honig**.

Der **Imker** **kümmert** sich um die **Bienen**.

Er **füttert** sie im **Winter** mit **Zuckerwasser**.

Dafür **erntet** er den **Honig** der **Bienen**.

Und er nimmt sich ihren **Wachs**.

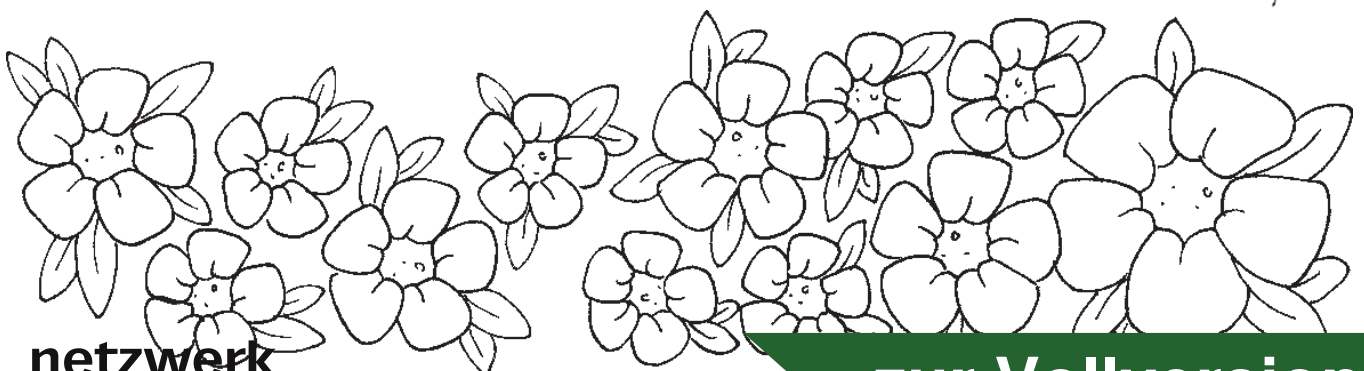
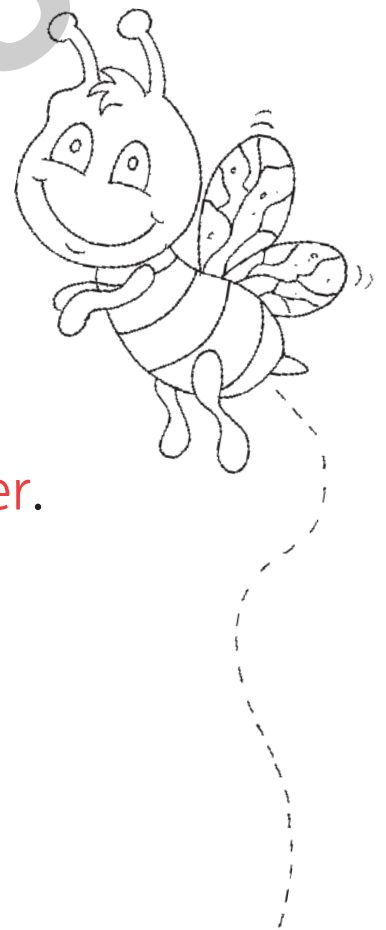



Von der Biene zum Imker - Leporello „Bienenstock“

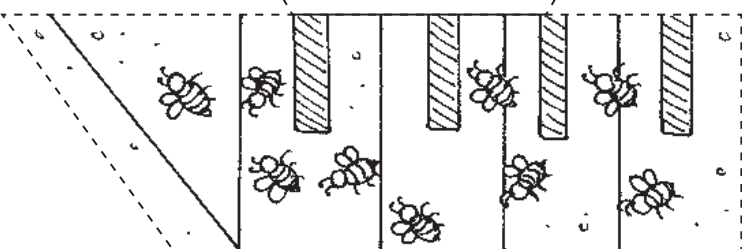
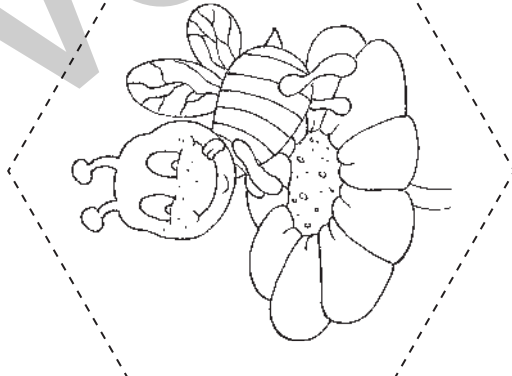
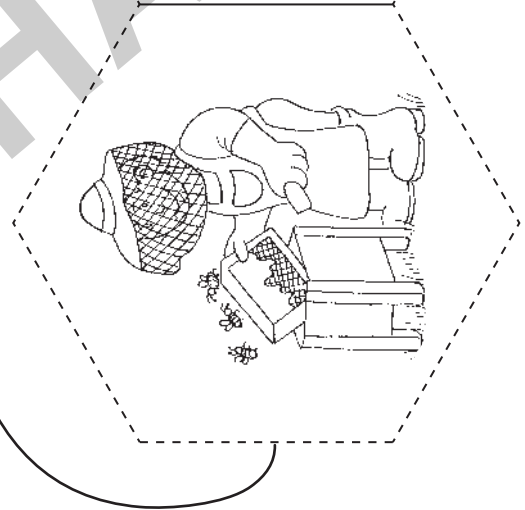
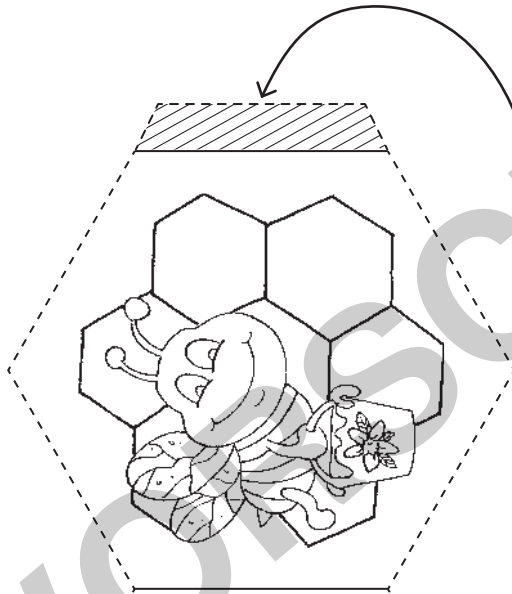
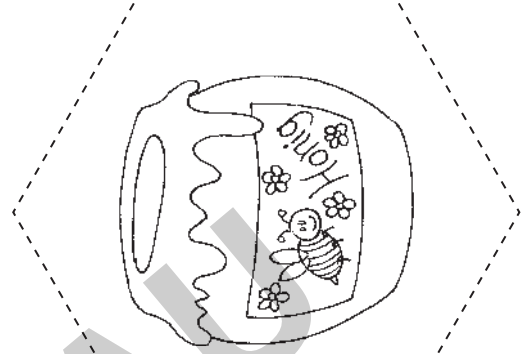
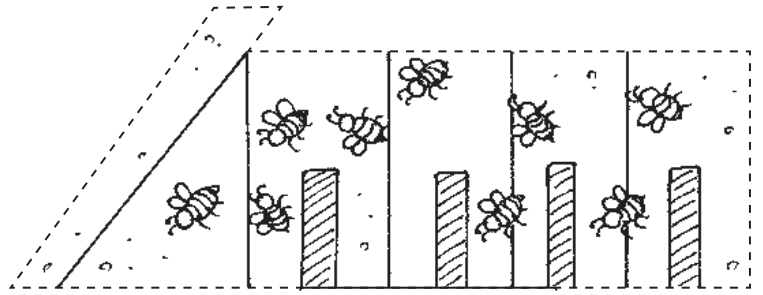
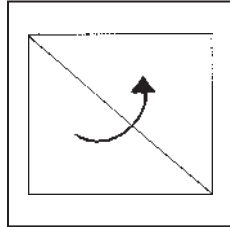
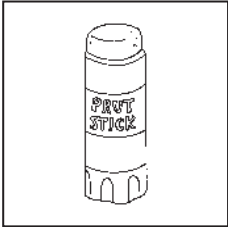
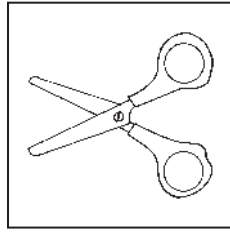
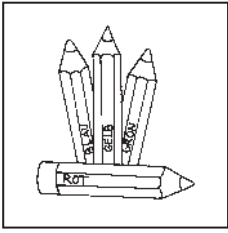
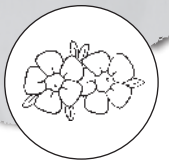

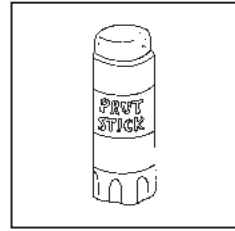
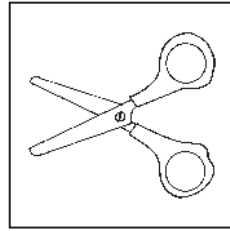
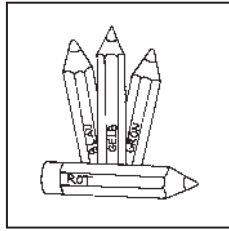
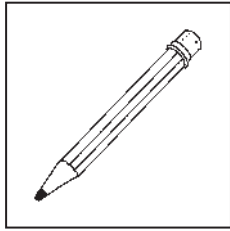
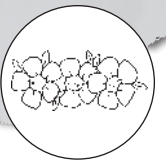

Von der Biene zum Imker



Die Biene macht Honig.

Wir essen Honig.

Der Imker erntet Honig.

Die Biene sammelt Nektar.

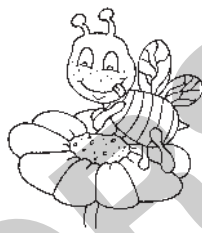

Four horizontal lines for writing.



Four horizontal lines for writing.



Four horizontal lines for writing.



Four horizontal lines for writing.