

Im Schulgebäude 1

 Schneide aus.

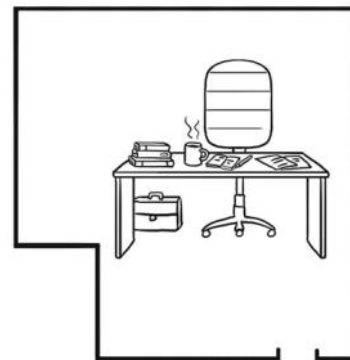
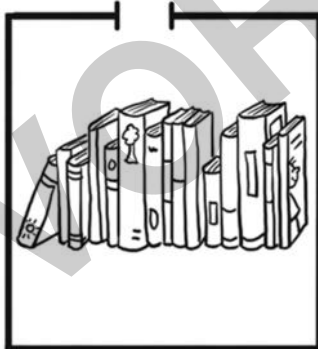
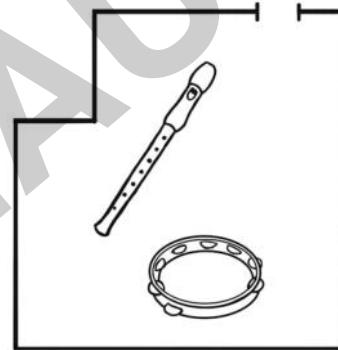
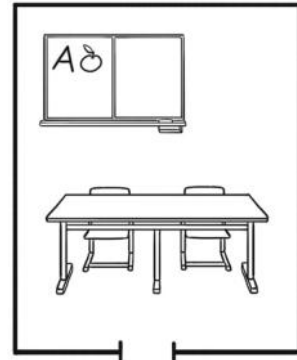
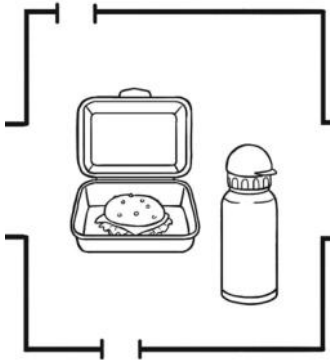

Im Klassenzimmer 1

 Schneide aus.

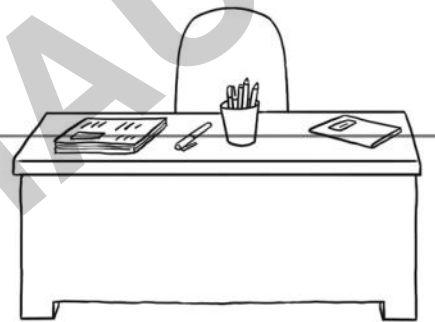
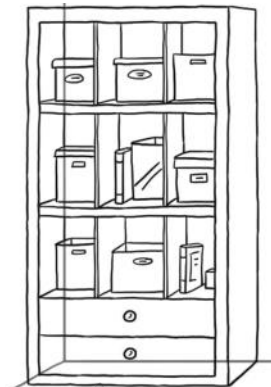
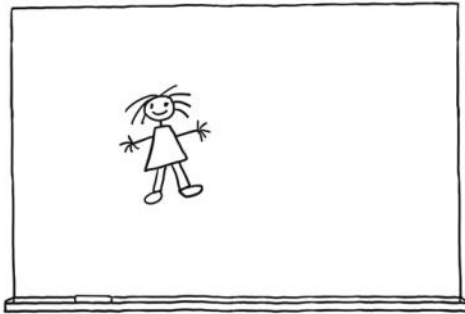



Klebe auf.

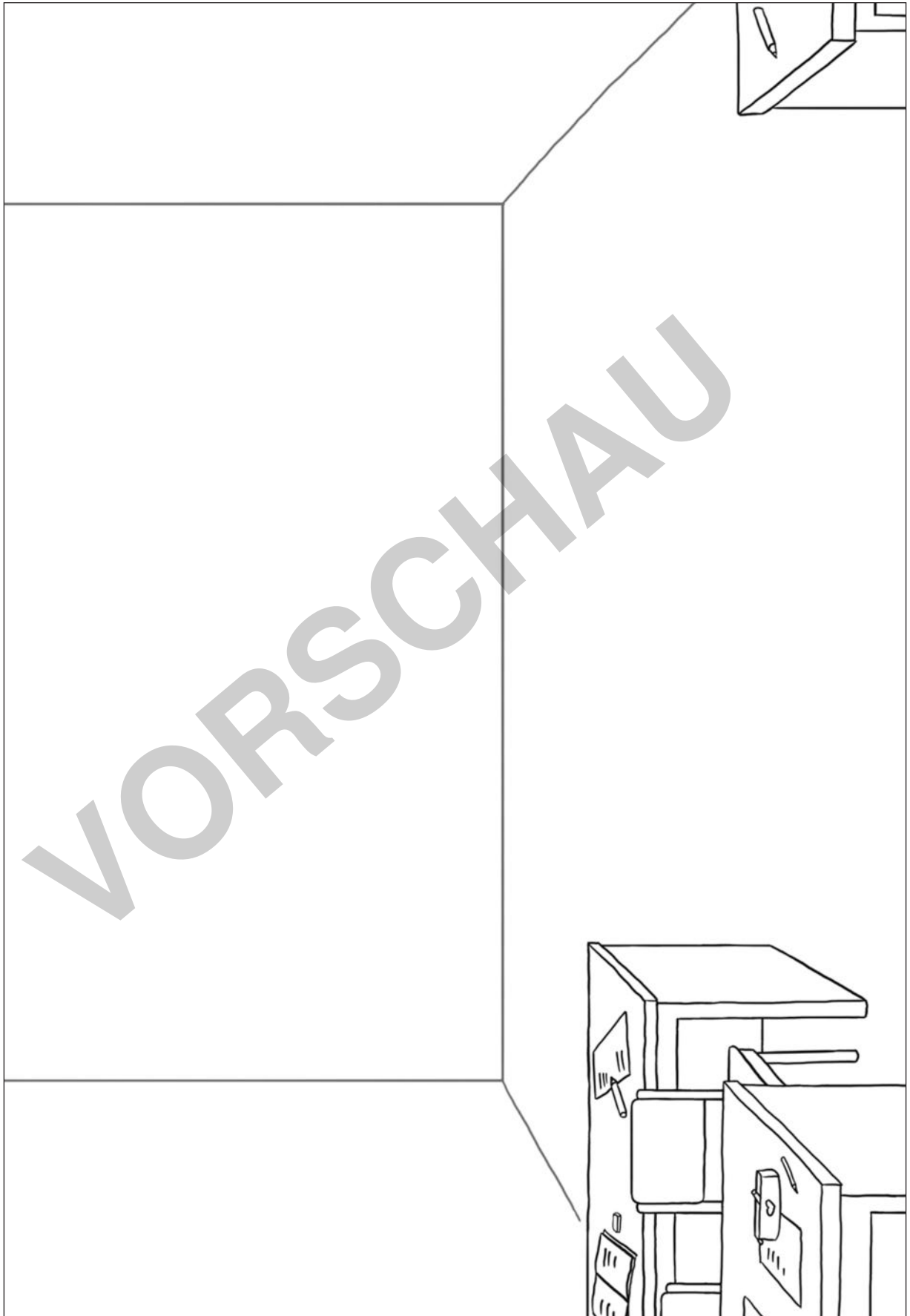

 Schreibe auf: Wer macht was?



Mein Schulranzen 1

 **Streiche durch:** Was soll nicht in den Ranzen?

 **Male an:** Was soll in den Ranzen?

