

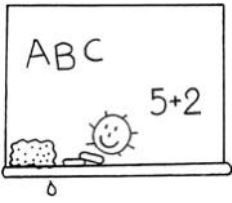

Name: _____

Datum: _____

Fill in  the words.



b o a r d

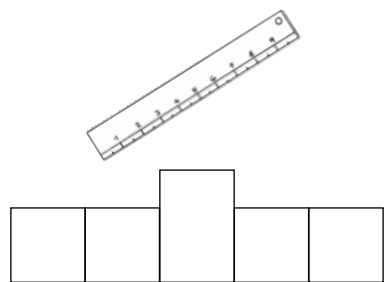
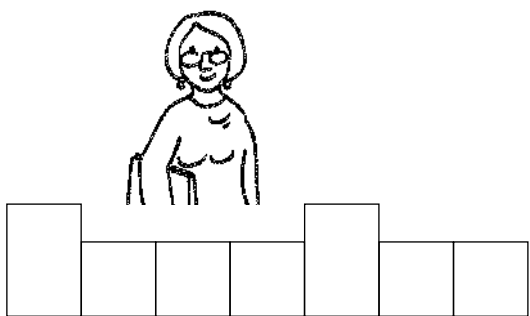
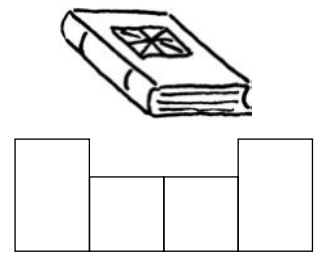
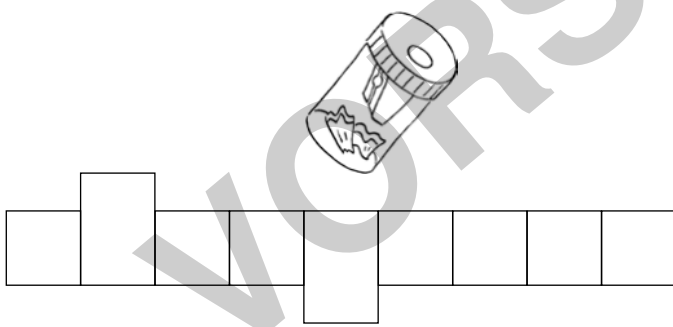
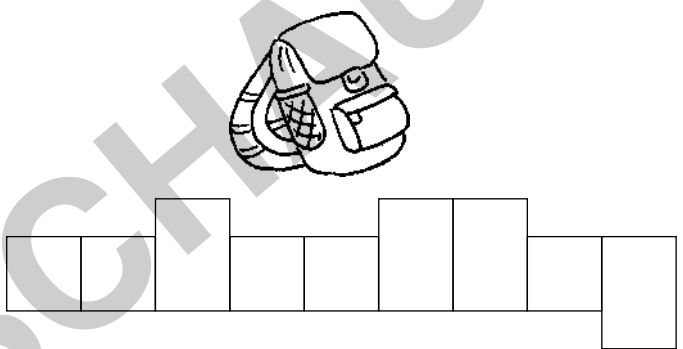
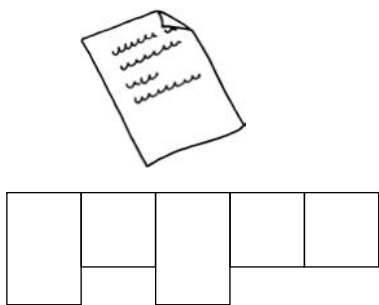
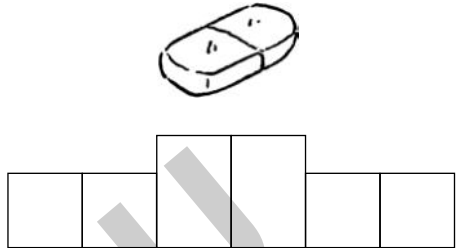
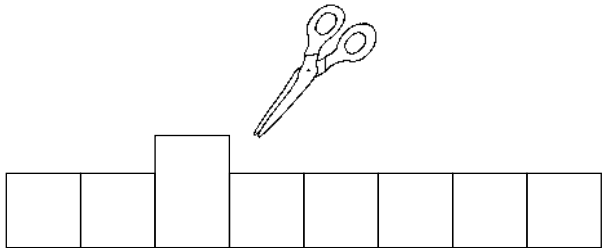
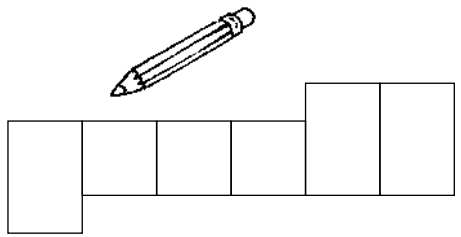

solutions: teacher • board • scissors • paper • school-bag • pencil • sharpener • rubber • ruler • book



Name: _____

Datum: _____

Fill in  the blanks.

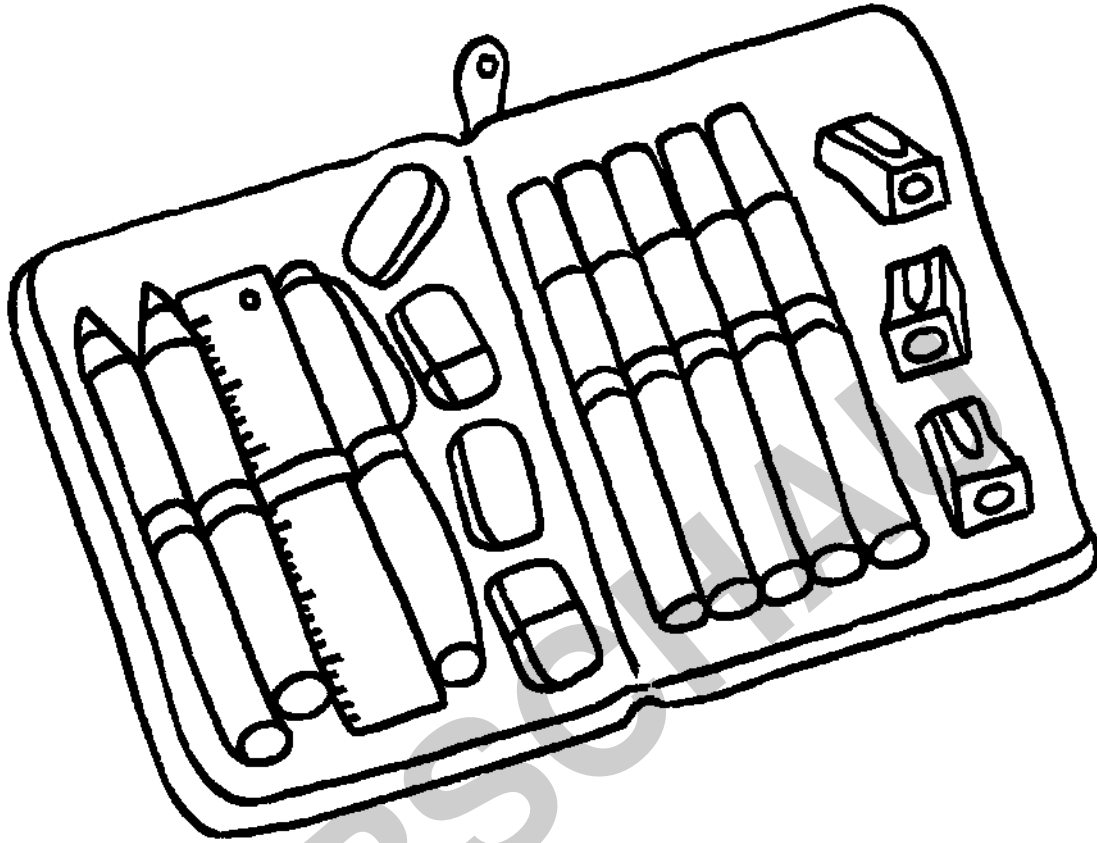

This is my _____.

The pencil _____ is red and _____.

There are _____ things in my _____ case.

There is a _____ and a _____.

There are 2 _____ and 5 felt _____.

There are 4 _____ and 3 _____.

solutions: blue • tips • pencil case • sharpeners • pencil • case • many • rubbers • ruler • pen • coloured pencils



Name: _____

Datum: _____

Colour  the picture and write  sentences.



helping words and phrases:

- I see a ... • There is a ... •
- The ... is ... •
- books • tables • chairs • schoolbag •
- scissors • pencil case • glue stick •
- pen • rubber • exercise book •
- timetable • ruler • desk • teacher •
- paper basket • poster • computer •
- sharpener • football • flowers •
- red • yellow • blue • green •
- orange • pink • purple • brown •
- black • grey • white • colourful

The schoolbag is blue and purple.
