

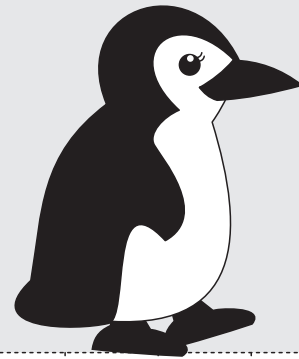

Mein Name / Datum

# Spiegelrätsel 2

**Aufgabe:** Spiegle das Objekt an den beiden Spiegelachsen!  
Male dann ein Objekt in deinen Lieblingsfarben aus!

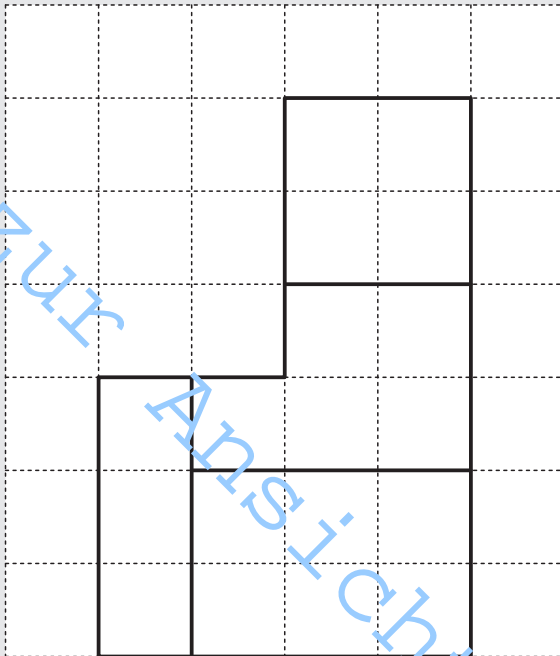

4

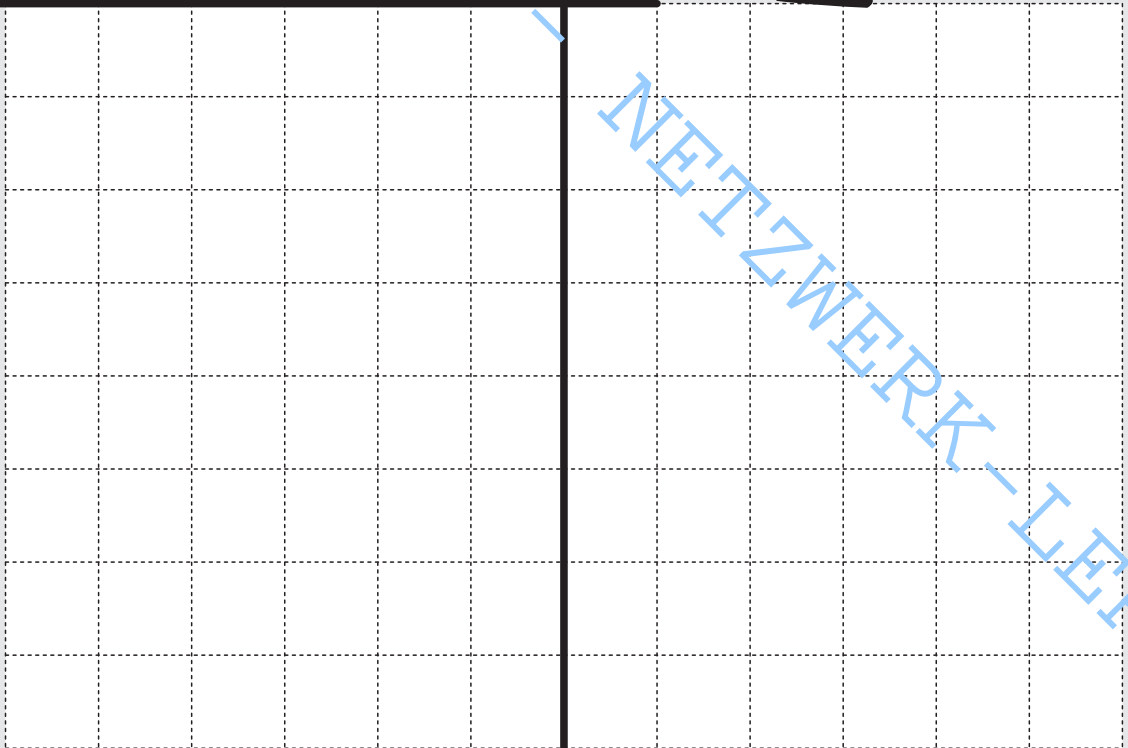



Mein Name / Datum

# Spiegelrätsel 3

**Aufgabe:**

Spiegle das Objekt an den beiden Spiegelachsen!  
Male dann ein Objekt in deinen Lieblingsfarben aus!

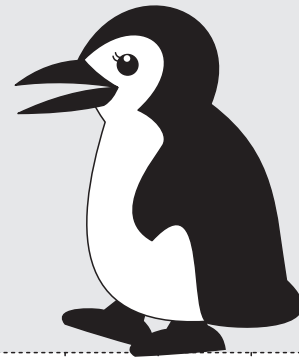
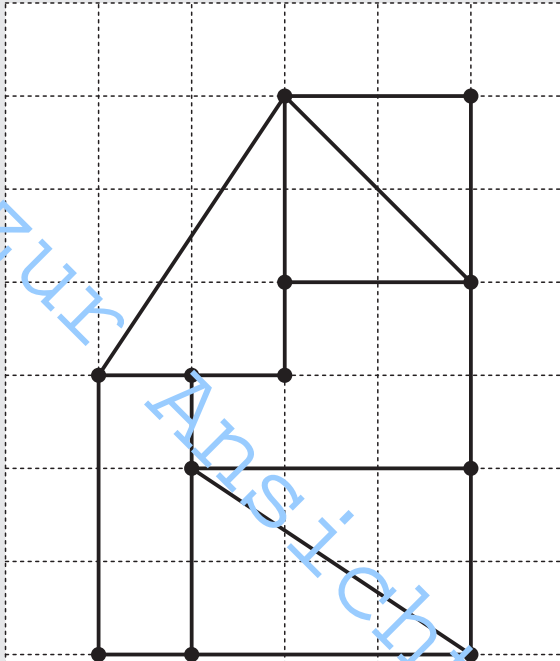

6

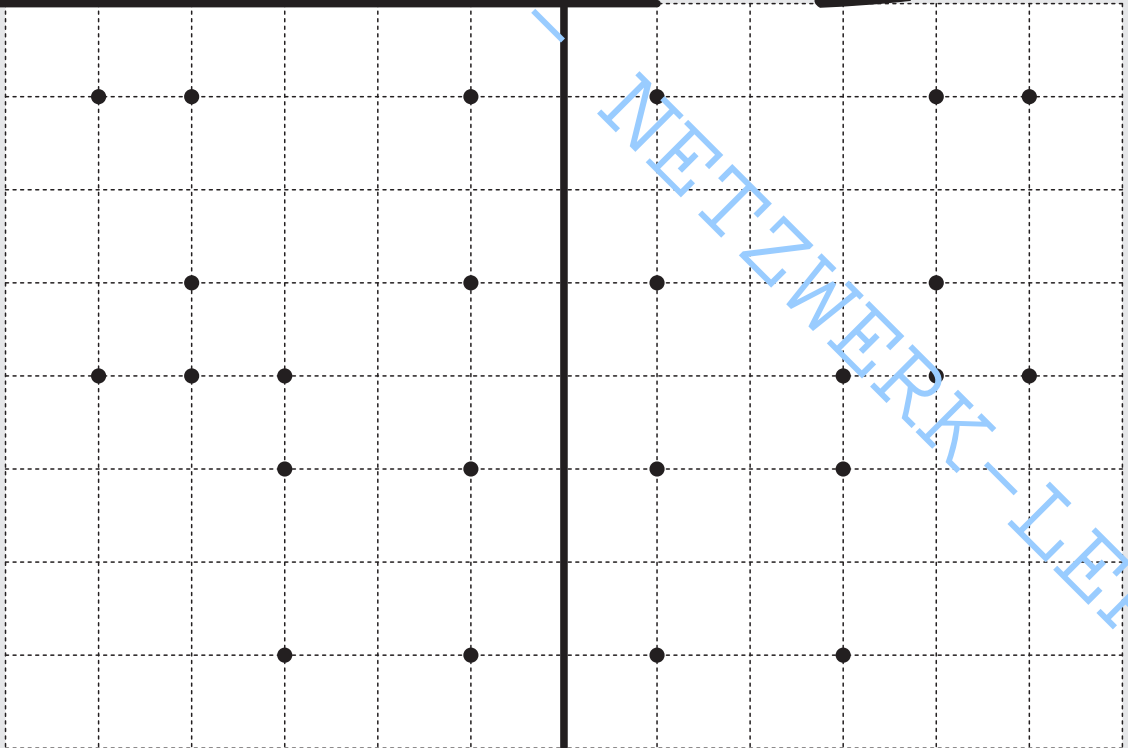



Mein Name / Datum

# Spiegelbuchstaben 1

**Aufgabe:**

Spiegle den Buchstaben an den beiden Spiegelachsen!  
Male dann ein Objekt in deinen Lieblingsfarben aus!

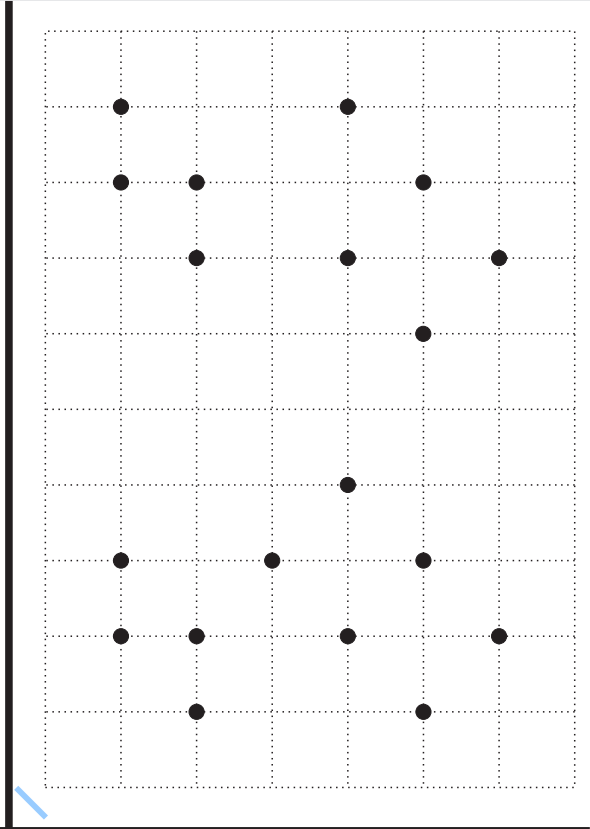
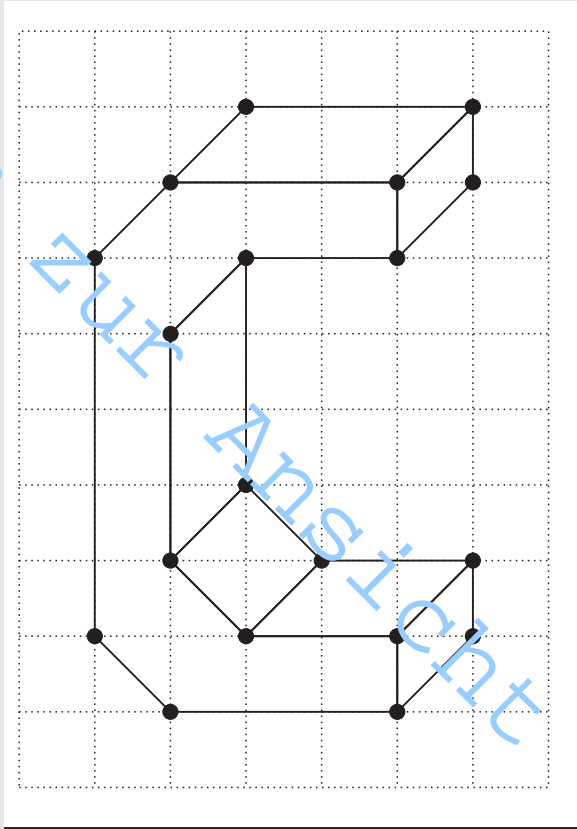
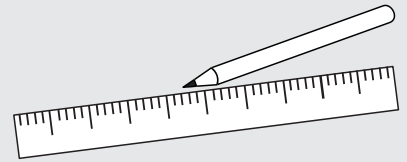

18

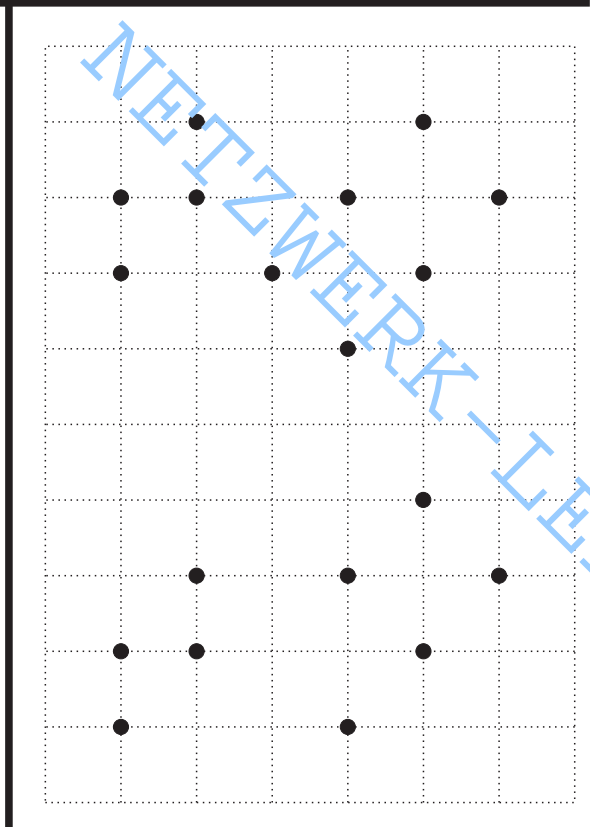
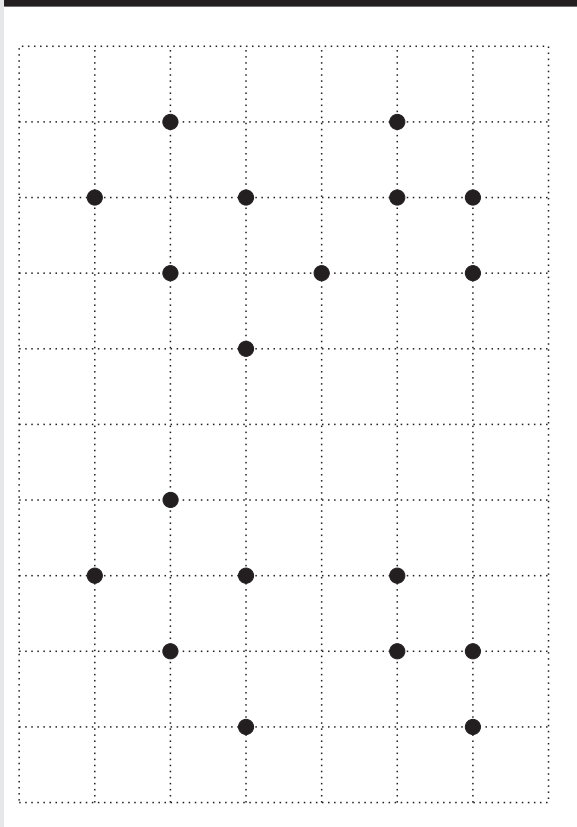



Mein Name / Datum

# Spiegelbilder 1 (Lösung)

**Aufgabe:**

Spiegle das Muster an allen Spiegelachsen!  
Male das fertige Bild in deinen Lieblingsfarben aus!

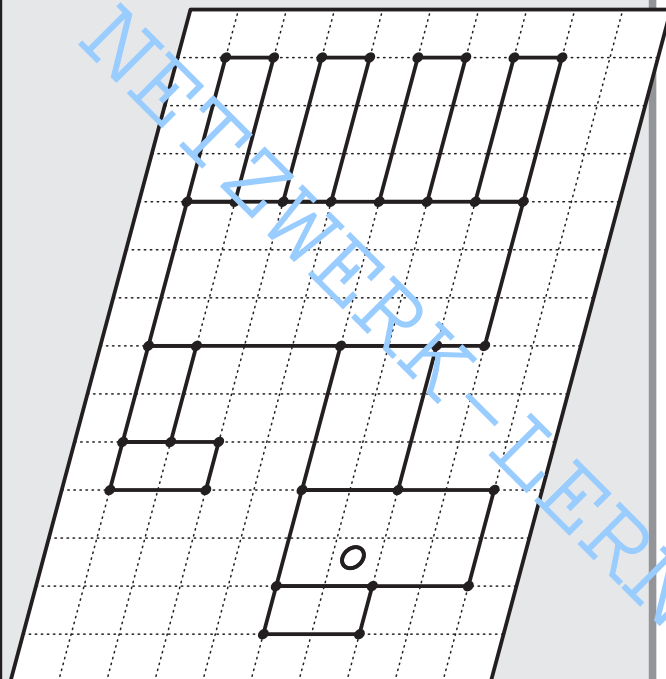
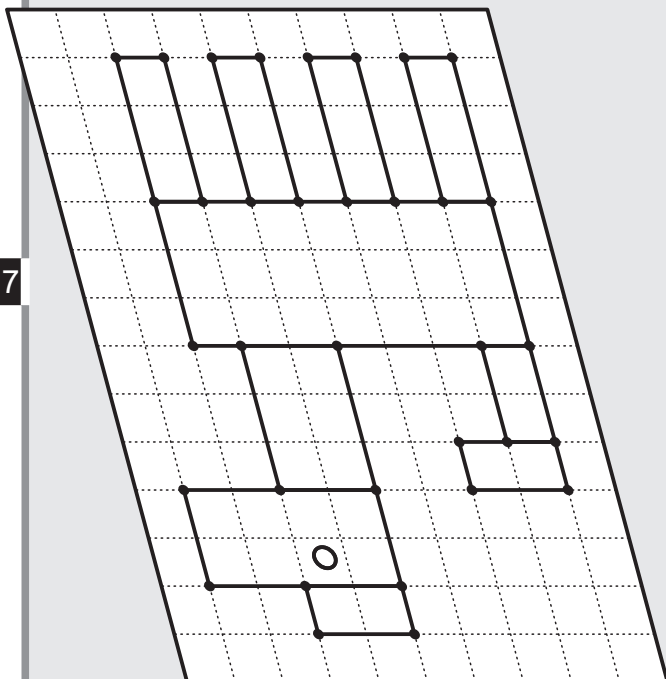
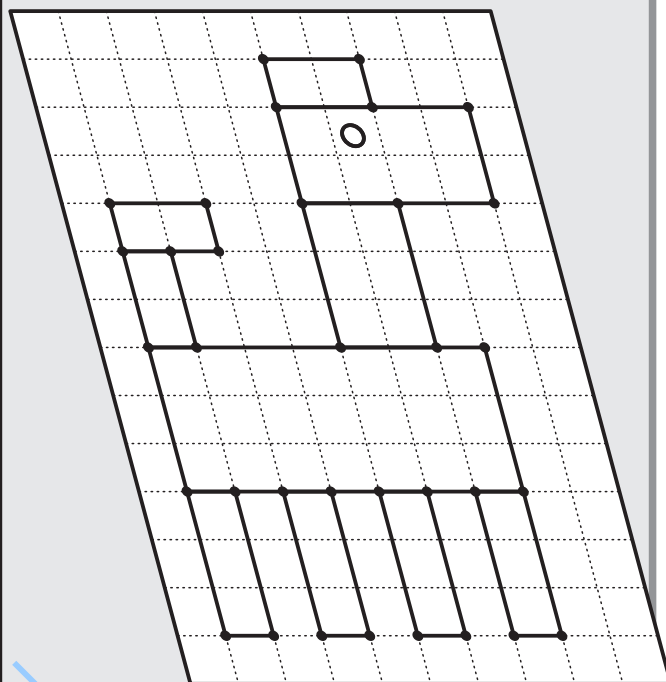
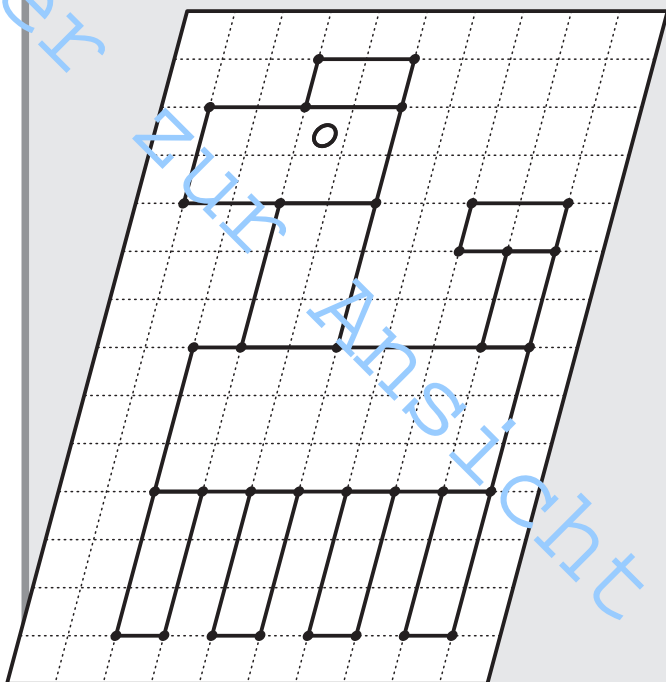
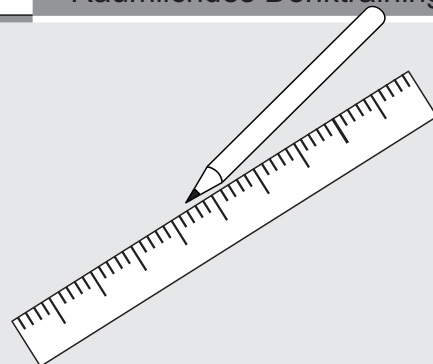

67



Mein Name / Datum

# Spiegelspaß 2

**Aufgabe:**

Spiegle das Muster an der Spiegelachse!  
Male das fertige Bild in deinen Lieblingsfarben aus!

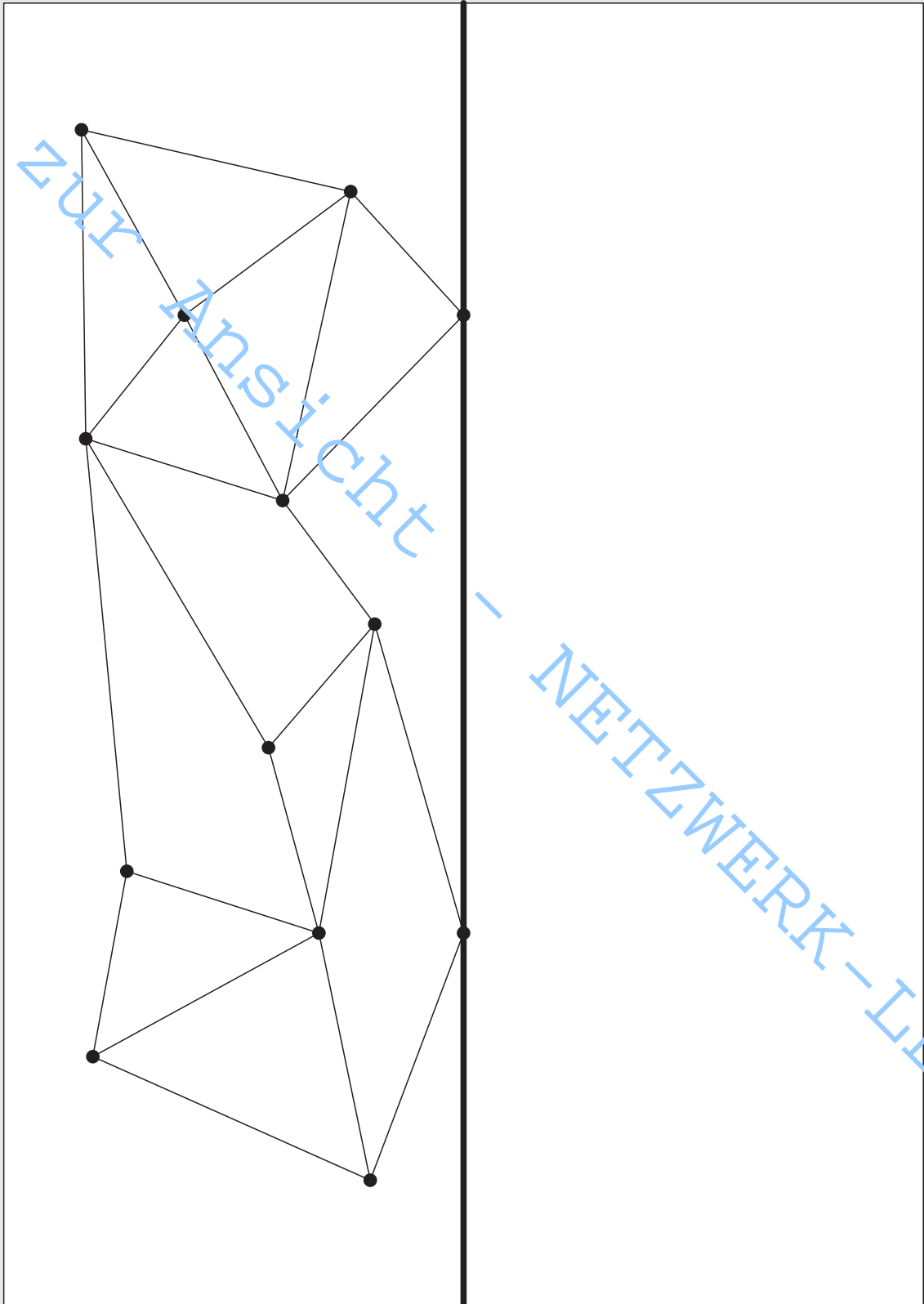
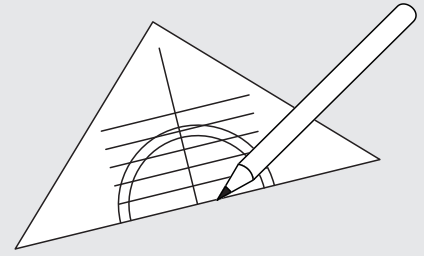

Muster

zur Ansicht

NETZWERK-LERNEN

80





Mein Name / Datum

# Gitterkreis 4

**Aufgabe:**

Spiegle das Muster an allen Spiegelachsen!  
Male das fertige Bild in deinen Lieblingsfarben aus!

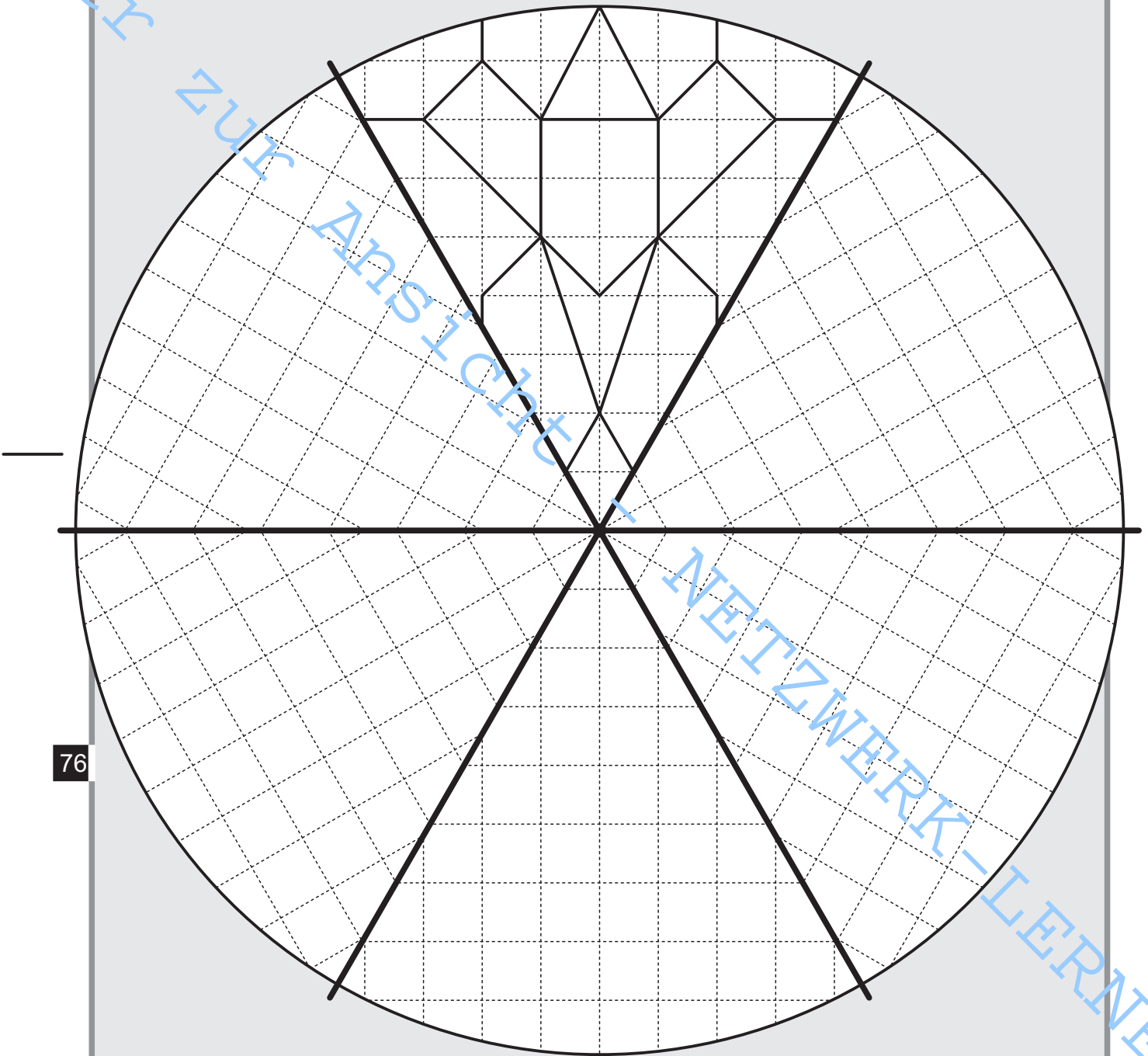
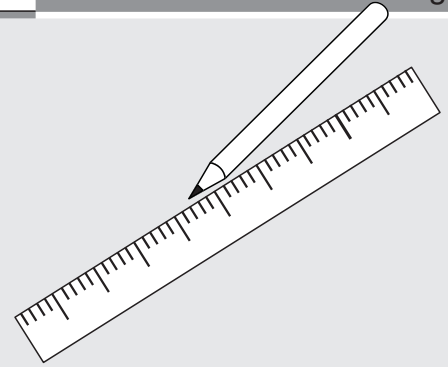

76

